

Spare Parts List

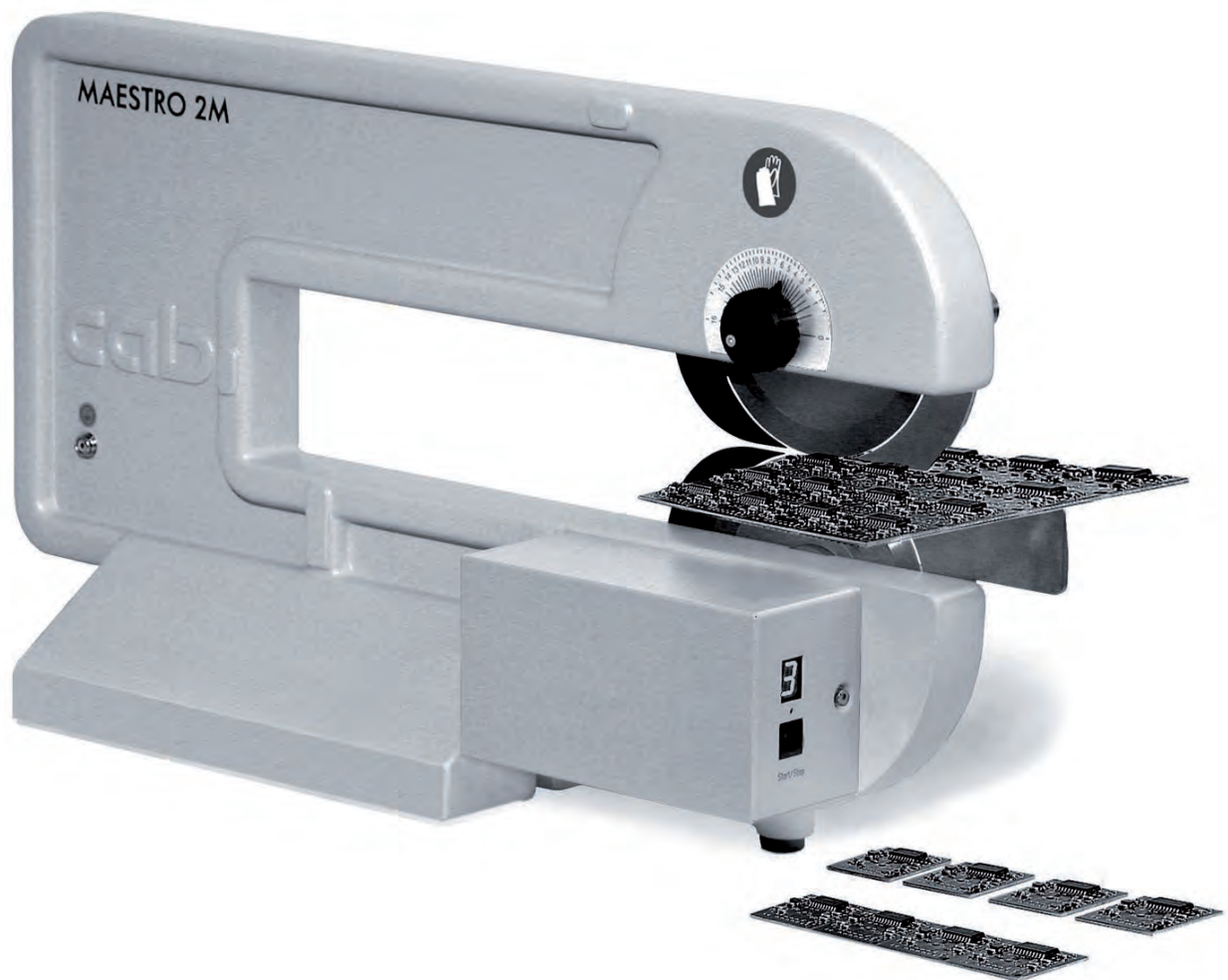

PCB Separator

MAESTRO 2/2M

Spare Parts List

for the following products

Description	Type
PCB Separator	MAESTRO 2
PCB Separator	MAESTRO 2M

Contents

1 Spare Parts	3
2 Spare Parts Register	6
3 Packaging/Accessories.....	7

Edition: 05/2019 - Part No. 9008720

Copyright

This documentation as well as translation hereof are property of cab Produkttechnik GmbH & Co. KG.

The replication, conversion, duplication or divulgement of the whole manual or parts of it for other intentions than its original intended purpose - in particular the procurement of spare parts for products sold by cab – demand the previous written authorisation by cab.

Editor

Regarding questions or comments please contact cab Produkttechnik GmbH & Co. KG.

Topicality

Due to the constant further development of our products discrepancies between documentation and product can occur.

Please check www.cabgmbh.com for the latest update.

Terms and conditions

Deliveries and performances are effected under the "General conditions of sale of cab"

Germany
cab Produkttechnik GmbH & Co KG
 Karlsruhe
 Phone +49 721 6626 0
www.cab.de

USA
cab Technology, Inc.
 Chelmsford, MA
 Phone +1 978 250 8321
www.cab.de/us

Taiwan
cab Technology Co., Ltd.
 Taipei
 Phone +886 (02) 8227 3966
www.cab.de/tw

China
cab (Shanghai) Trading Co., Ltd.
 Guangzhou
 Phone +86 (020) 2831 7358
www.cab.de/cn



France
cab Technologies S.à.r.l.
 Niedermodern
 Phone +33 388 722501
www.cab.de/fr

Mexico
cab Technology, Inc.
 Juárez
 Phone +52 656 682 4301
www.cab.de/es

China
cab (Shanghai) Trading Co., Ltd.
 Shanghai
 Phone +86 (021) 6236 3161
www.cab.de/cn

South Africa
cab Technology (Pty) Ltd.
 Randburg
 Phone +27 11 886 3580
www.cab.de/za

	MAESTRO 2	8930740.001
	MAESTRO 2M	8930710.001





	8931617.001
	8931622.001





	8931612.001
	5903026.001
	8930509.001
	8931626.001

	MAESTRO 2	8930734.001
	MAESTRO 2M	-
	MAESTRO 2	-
	MAESTRO 2M	5902512.001
	5903044.001	
	MAESTRO 2	8930716.001
	MAESTRO 2M	-
	MAESTRO 2	-
	MAESTRO 2M	8930712.001

	8930585.001
	8933661.001
	8930508.001
	5902101.001













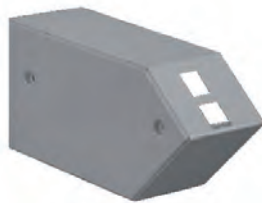





	8930702.001
	8930522.001
	5903010.001
	8930590.001

	5903021.001
	5903025.001
	8930514.001
	5902103.001

	5903021.001
	5903025.001
	8930744.001
	8930745.001
	8930528.001



	MAESTRO 2 - MAESTRO 2M 5903035.001
	MAESTRO 2 - MAESTRO 2M 8930558.001
	MAESTRO 2 - MAESTRO 2M 5903501.001
	MAESTRO 2 - MAESTRO 2M 8930732.001 ¹⁾
	MAESTRO 2 - MAESTRO 2M 5903035.001 ¹⁾
	MAESTRO 2 - MAESTRO 2M 8930562.001 ¹⁾
	MAESTRO 2 - MAESTRO 2M 5903501.001 ¹⁾
	MAESTRO 2 - MAESTRO 2M 8930559.001 ¹⁾
	MAESTRO 2 - MAESTRO 2M 8930566.001 ¹⁾
	MAESTRO 2 - MAESTRO 2M 5904061.001 ¹⁾
	MAESTRO 2 - MAESTRO 2M 8930597.001 ¹⁾
	MAESTRO 2 - MAESTRO 2M 5902142.001 ¹⁾
	MAESTRO 2 - MAESTRO 2M 5900061.001 ²⁾
	MAESTRO 2 - MAESTRO 2M 8936623.001 ²⁾
	MAESTRO 2 - MAESTRO 2M 5904515.001 ²⁾
	MAESTRO 2 - MAESTRO 2M 5902281.001 ²⁾
	MAESTRO 2 - MAESTRO 2M 8936621.001 ²⁾
	MAESTRO 2 - MAESTRO 2M 8936628.001 ²⁾
	5902241.001 ²⁾



¹⁾ up to serial no. 1996
²⁾ from serial no. 1997



	MAESTRO 2 - MAESTRO 2M 5900023.001 ¹⁾
	MAESTRO 2 - MAESTRO 2M 8930554.001 ¹⁾
	MAESTRO 2 - MAESTRO 2M 8930741.001 ¹⁾
	MAESTRO 2 - MAESTRO 2M 5903003.001 ¹⁾
	MAESTRO 2 - MAESTRO 2M 5902241.001 ¹⁾
	MAESTRO 2 - MAESTRO 2M 8936633.001 ²⁾
	MAESTRO 2 - MAESTRO 2M 5903003.001 ²⁾
	MAESTRO 2 - MAESTRO 2M 5902241.001 ²⁾
	MAESTRO 2 - MAESTRO 2M 5903003.001 ²⁾
	MAESTRO 2 - MAESTRO 2M 5902241.001 ²⁾
	MAESTRO 2 - MAESTRO 2M 5900514.001 ¹⁾
	MAESTRO 2 - MAESTRO 2M 5903077.001 ¹⁾
	MAESTRO 2 - MAESTRO 2M 5903004.001 ¹⁾
	MAESTRO 2 - MAESTRO 2M 5902505.001 ¹⁾
	MAESTRO 2 - MAESTRO 2M 8930739.001 ³⁾
	
	MAESTRO 2 - MAESTRO 2M 8932502.001 ⁴⁾
	MAESTRO 2 - MAESTRO 2M 5901574.001



¹⁾ up to serial no. 1996
²⁾ from serial no. 1997
³⁾ up to serial no. 821
⁴⁾ from serial no. 822

1 Spare Parts

	MAESTRO 2	-
	MAESTRO 2M	8930598.001
	MAESTRO 2	-
	MAESTRO 2M	5902075.001

	MAESTRO 2	-
	MAESTRO 2M	5902505.001
	MAESTRO 2	-
	MAESTRO 2M	5903004.001
	MAESTRO 2	-
	MAESTRO 2M	8930571.001 ³⁾

	MAESTRO 2	-
	MAESTRO 2M	8932507.001 ⁴⁾
	MAESTRO 2	-
	MAESTRO 2M	5900516.001

	MAESTRO 2	-
	MAESTRO 2M	5902501.001
	MAESTRO 2	-
	MAESTRO 2M	5903011.001
	MAESTRO 2	-
	MAESTRO 2M	5903520.001
	MAESTRO 2	-
	MAESTRO 2M	8930713.001

	MAESTRO 2	-
	MAESTRO 2M	5902135.001

	MAESTRO 2	-
	MAESTRO 2M	8930715.001
	MAESTRO 2	-
	MAESTRO 2M	5902510.001
	MAESTRO 2	-
	MAESTRO 2M	5903011.001
	MAESTRO 2	-
	MAESTRO 2M	5903033.001
	MAESTRO 2	-
	MAESTRO 2M	5916907.001
	MAESTRO 2	-
	MAESTRO 2M	5916915.001

³⁾ up to serial no. 821
⁴⁾ from serial no. 822

	MAESTRO 2	-
	MAESTRO 2M	5901505.001

	MAESTRO 2	-
	MAESTRO 2M	5550611.001

	5909002.001
--	-------------

Pos.	Figure/Page		Part No.	Description	PU	SPR				Serial No.	
										from	to
1		4	5900023.001	Distance Bolt M4x60	10					1996	
2		4	5900061.001	Distance Bolt M4x25	10					1997	
3		4	5900514.001	Spacer Bushing PA M3x8	10						1996
4			5	5900516.001	Spacer Bushing PA M3x5	10					
5			5	5901505.001	Cable Clamp L=102	10					
6		4	5901574.001	Cable Clamp	10						
7			5	5902075.001	Flush Screw DIN965-M4x8	10					
8	3		5902101.001	Flush Screw DIN7991-M6x16	10						
9	3		5902103.001	Flush Screw DIN963-M4x14	10						
10			5	5902135.001	Flush Screw DIN965-M4x40	10					
11		4	5902142.001	Screw DIN912-M5x20	10						1996
12		4	5902241.001	Screw DIN7984-M4x10	10						
13		4	5902281.001	Screw DIN7984-M5x12	10					1997	
14			5	5902501.001	Nut DIN934-M4	10					
15		4	5	5902505.001	Nut DIN934-M3	10					
16			5	5902510.001	Nut DIN934-M4	10					
17	3		5902512.001	Nut DIN439-BM10	10						
18		4	5903003.001	Washer DIN125-A4.3	10						
19		4	5	5903004.001	Washer DIN125-A3.2	10					
20	3		5903010.001	Spring Washer DIN137-A6	10						
21			5	5903011.001	Toothed Washer DIN6797-A4.3	10					
22	3		5903021.001	Washer DIN988-6x12x0.1	10						
23	3		5903025.001	Washer DIN988-6x12x0.2	10						
24	3		5903026.001	Washer DIN988-15x21x0.1	10						
25			5	5903033.001	Washer DIN125-A4.3	10					
26		4	5903035.001	Washer DIN988-8x14x1.0	10						
27	3		5903044.001	Washer DIN125-A10.5	10						
28		4	5903077.001	Washer 3.2x8x1.5	10						1996
29		4	5903501.001	E-Ring DIN6799-7	10						
30			5	5903520.001	Washer DIN7349-4.3	10					
31		4	5904061.001	Grooved Pin DIN1473-3x20	10						1996
32		4	5904515.001	Set Screw DIN913-M4x8	10					1997	
33			5	5916907.001	Fuse 5x20 T1.0A	5		B	C	D	
34			5	5916915.001	Fuse 5x20 T0.5A	5		B	C	D	
35	3		8930508.001	Plate	1						
36	3		8930509.001	Circular (Upper) Blade	1	A	B	C	D		
37	3		8930514.001	Guide	1			C	D		
38	3		8930522.001	Guide cpl.	1			C	D		
39	3		8930528.001	Screw	1						
40		4	8930554.001	Window	1						1996
41		4	8930558.001	Gear with Freewheel	1						
42		4	8930559.001	Distance Bolt	1						1996
43		4	8930562.001	Gear Wheel cpl.	1						1996
44		4	8930566.001	Gearwheel Motor	1						1996
45			5	8930571.001	PCB Control	1		B	C	D	821
46	3		8930585.001	Washer	1						
47	3		8930590.001	Screw	1						
48		4	8930597.001	Motor cpl.	1		B	C	D		1996
49			5	8930598.001	Baseplate with Bolts	1					
50	3		8930702.001	Washer	1						
51	3		8930710.001	Frame cpl.	1						
52	3		8930712.001	Blade Shaft cpl.	1						
53			5	8930713.001	Transformer cpl.	1				D	
54			5	8930715.001	Power Input Module cpl.	1					
55	3		8930716.001	Blade Shaft cpl.	1						
56		4	8930732.001	Bolt	1						1996
57	3		8930734.001	Nut	1						
58		4	8930739.001	PCB Control Panel assem.	1		B	C	D		821
59	3		8930740.001	Frame cpl.	1						
60		4	8930741.001	Bonnet	1						1996
61	3		8930744.001	Upper Shield	1	A	B	C	D		
62	3		8930745.001	Lower Shield	1	A	B	C	D		
63	3		8931612.001	Washer	1						
64	3		8931617.001	Scale	1						
65	3		8931622.001	Adjusting Mechanism	1				D		
66	3		8931626.001	Knurled Nut cpl.	1				D		

PU Package unit

SPR Recommendation

A - wearing parts and accessories

B - recommended spare parts for quick repair

C - recommended spare parts for distributors

D - recommended spare parts for central stores

2 Spare Parts Register

7

Pos.	Figure/Page		Part No.	Description	PU	SPR				Serial No.	
										from	to
67		4	8932502.001	PCB Display assem.	1		B	C	D	822	
68		5	8932507.001	PCB Control cpl.	1		B	C	D	822	
69	3		8933661.001	Circular (Lower) Blade	1	A	B	C	D		
70		4	8936621.001	Motor Plate	1					1997	
71		4	8936623.001	Gear Wheel Z18	1					1997	
72		4	8936628.001	Motor cpl.	1		B	C	D	1997	
73		4	8936633.001	Bonnet cpl.	1					1997	

3 Packaging/Accessories

Pos.	Figure/Page		Part No.	Description	PU	SPR				Serial No.	
										from	to
74		5	5550611.001	Power Cable Type E+F	1						
75		5	5909002.001	Key DIN911-2	1						
76			8930517.001	Packaging	1						

PU Package unit

SPR Recommendation

A - wearing parts and accessories

B - recommended spare parts for quick repair

C - recommended spare parts for distributors

D - recommended spare parts for central stores

This page is intentionally left blank.