



Label Dispenser HS 150

Spare Parts List for the following products

Description	Type
Label Dispenser	HS 150

Edition: 9/2008 - Part No. 9008722

Copyright

This documentation as well as translation hereof are property of cab Produkttechnik GmbH & Co. KG.

The replication, conversion, duplication or divulgement of the whole manual or parts of it for other intentions than its original intended purpose - in particular the procurement of spare parts for products sold by cab – demand the previous written authorisation by cab.

Editor

Regarding questions or comments please contact
cab Produkttechnik GmbH & Co. KG.

Topicality

Due to the constant further development of our products discrepancies between documentation and product can occur.

Please check www.cabgmbh.com for the latest update.

Terms and conditions

Deliveries and performances are effected under the “General conditions of sale of cab”

Germany

cab Produkttechnik
GmbH & Co KG
Postfach 1904
D-76007 Karlsruhe
Wilhelm-Schickard-Str. 14
D-76131 Karlsruhe
Telefon +49 721 6626-0
Telefax +49 721 6626-249
www.cabgmbh.com
info@cabgmbh.com

Other subsidiaries on request.

France

cab technologies s.a.r.l.
B.P. 50020
Z.A. Nord du Val de Moder
F-67350 Niedermodern
Téléphone +33 388 722 501
info@cab-technologies.fr

USA

cab Technology Inc.
90 Progress Avenue Unit #2
Tyngsboro MA, 01879
Phone +1 978 649 0293
www.cabtechn.com
info@cabtechn.com

Asia 亞洲分公司

希愛比科技股份有限公司
cab Technology Co, Ltd.
台灣台北縣板橋市
民生路一段33號十九樓之一
19F-1, No. 33, Sec. 1,
Min Sheng Road
Panchiao 220,
Taipei, Taiwan, R.O.C.
電話 Phone +886 2 2950 9185
網址 www.cabasia.net
詢問 cabasia@cabgmbh.com

Spare Parts

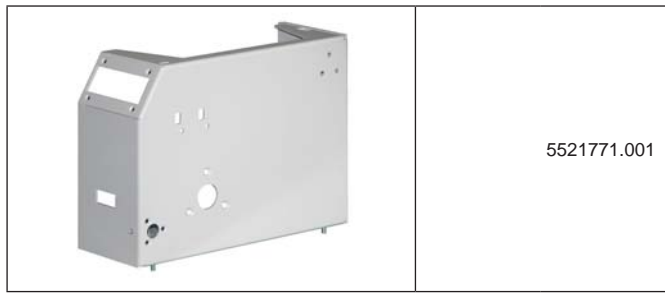

5521771.001

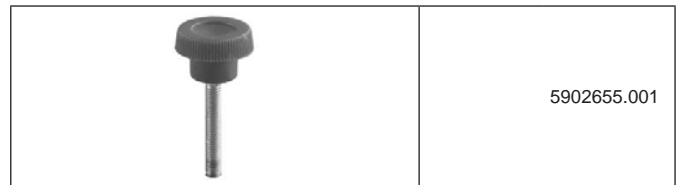

5902655.001



5903004.001



5943021.001



5900075.001

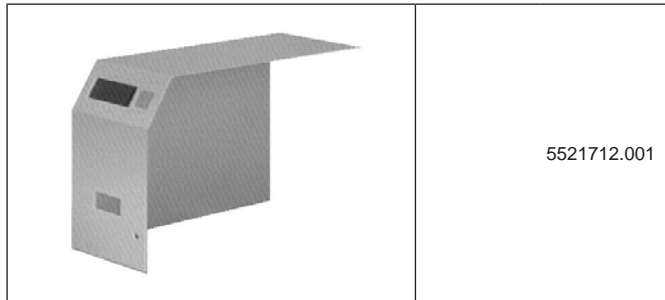

5521712.001



5521705.001



5903005.001

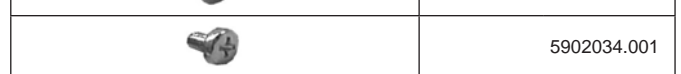

5902034.001



5917072.001



5902070.001



5903033.001



5903011.001



5902510.001



5521773.001



5903003.001



5905141.001



5902034.001

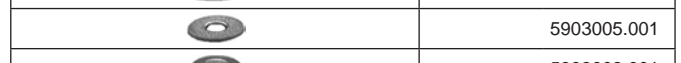

5903005.001



5902501.001



5521722.001



5521739.001



5902102.001



5902156.001



5521777.001



5530246.001



5903037.001



5903038.001



5902159.001







5903516.001



5521707.001





5521748.001





	5521706.001
	5903516.001
	5903038.001
	5903505.001







	5521752.001
	5520860.001
	5902073.001
	5902089.001

	5521757.001
	5521732.001
	5903517.001
	5902505.001

	5521781.001
---	-------------

	5900013.001
	5903520.001
	5521700.001
	5903003.001
	5902053.001
	5901574.001

	5902068.001
	5900012.001
	5551103.001
	5903077.001
	5902505.001

	5903009.001
	5902505.001
	5551107.001
	5551101.001
	5521725.001
	5900514.001
	5902069.001

	5551110.001
	5903033.001
	5903038.001
	5902510.001
	5530777.001
	5905140.001
	5901505.001
	5905143.001
	5550611.001
	5916910.001
	5916911.001

Pos.	Figure/Page		Part No.	Description	PU	SPR				Serial No.	
										from	to
1		4	5520860.001	Stopper	10			C	D		
2		4	5521700.001	Motor cpl.	1			C	D		
3	3		5521705.001	Dispense Plate	1						
4		4	5521706.001	Gear Wheel cpl.	1			C	D		
5	3		5521707.001	Roller	1						
6	3		5521712.001	Cover mount.	1						
7	3		5521722.001	Shaft Media Roll cpl.	1						
8		4	5521725.001	Insulating Plate	1						
9		4	5521732.001	Shield	1						
10	3		5521739.001	Rewinder Bearing	1			C	D		
11	3		5521748.001	Clamp	1			C	D		
12		4	5521752.001	Bearing	1			C	D		
13		4	5521757.001	Bracket cpl.	1						
14	3		5521771.001	Center Mounting Plate cpl.	1						
15	3		5521773.001	Foot cpl.	1						
16	3		5521777.001	Axle	1						
17		4	5521781.001	Switch mount.	1		B	C	D		
18	3		5530246.001	Rewinder	1						
19		5	5530777.001	Cable	1						
20		4	5551101.001	PCB Control assem.	1		B	C	D		
21		4	5551103.001	PCB Display assem.	1		B	C	D		
22		4	5551107.001	Controller prog.	1						
23		5	5551110.001	Power Input Module cpl.	1		B	C	D		
24		4	5900012.001	Distance Bolt M3x8	10						
25		4	5900013.001	Distance Bolt M4x50	10						
26	3		5900075.001	Distance Bolt M3x5	10						
27		4	5900514.001	Spacer Bushing PA M3x8	10						
28		5	5901505.001	Cable Clamp L=102	10						
29		4	5901574.001	Cable Clamp	10						
30	3		5902034.001	Screw DIN7985-M4x8	10						
31		4	5902053.001	Screw DIN7985-M4x20	10						
32		4	5902068.001	Screw DIN965-M3x6	10						
33		4	5902069.001	Screw DIN7985-M3x8	10						
34	3		5902070.001	Screw DIN7985-M4x14	10						
35		4	5902073.001	Screw DIN965-M3x10	10						
36		4	5902089.001	Screw DIN653-M4x12	10						
37	3		5902102.001	Screw DIN7516-A-M4x12	10						
38	3		5902156.001	Screw DIN965-M4x12	10						
39	3		5902159.001	Screw DIN912-M5x12	10						
40	3		5902501.001	Nut DIN934-M4	10						
41		4	5902505.001	Nut DIN934-M3	10						
42	3	5	5902510.001	Nut DIN934-M4	10						
43	3		5902655.001	Screw M3x20	10						
44	3	4	5903003.001	Washer DIN125-A4.3	10						
45	3		5903004.001	Washer DIN125-A3.2	10						
46	3		5903005.001	Washer DIN9021-4.3	10						
47		4	5903009.001	Washer DIN9021-3.2	10						
48	3	5	5903011.001	Toothed Washer DIN6797-A4.3	10						
49	3	5	5903033.001	Washer DIN125-A4.3	10						
50	3		5903037.001	Washer DIN9021-5.3	10						
51	3	4	5903038.001	Washer DIN988-8x14x0.2	10						
52		4	5903077.001	Washer 3,2x8x1.5	10						
53		4	5903505.001	E-Ring DIN6799-5	10						
54	3	4	5903516.001	Snap Ring DIN471-8x0.8	10						
55		4	5903517.001	Snap Ring DIN471-12x1	10						
56		4	5903520.001	Washer DIN7349-4.3	10						
57		5	5905140.001	Adhesive Plate 19x19	10						
58	3		5905141.001	Foot	10						
59		5	5905143.001	Power Switch	1		B	C	D		
60		5	5916910.001	Fuse 5x20 T0.25A	5		B	C	D		
61		5	5916911.001	Fuse 5x20 T0.5A	5		B	C	D		
62	3		5917072.001	Tab DIN46244-A4	5						
63	3		5943021.001	Media Retainer	1						

PU Package unit

SPR Recommendation

A - wearing parts and accessories

B - recommended spare parts for quick repair

C - recommended spare parts for distributors

D - recommended spare parts for central stores

Spare Parts Register

Technical Documents

Pos.	Figure/Page	Part No.	Description	PU	SPR	Serial No.	
						from	to
64		5521769.001	Operator's Manual HS150 G/E/F	1			

Packaging/Accessories

Pos.	Figure/Page	Part No.	Description	PU	SPR	Serial No.	
						from	to
65		5550611.001	Power Cable Type E+F	1			
66		9109100.001	Packaging	1			

PU Package unit
 SPR Recommendation
 A - wearing parts and accessories
 B - recommended spare parts for quick repair

C - recommended spare parts for distributors
 D - recommended spare parts for central stores

This page is intentionally left blank.