

Status: 03/2025



Products need labeling
Print modules
for industrial use

PX Q
Made in Germany

Print modules PX Q

Full functionality, high reliability, comfortable operation and low downtime related to maintenance! The PX Q print and peel-off module has been designed specifically for printing and labeling fully automatically in industrial applications. It can be integrated in any orientation of assembly to solve even complex marking tasks.

A torsion-resistant cast aluminum construction is basis to assemble all the components of the print mechanics. Food-safe coating and stainless steel casings add to the perfect shape with special features. Screwing is compatible to the devices of competitors.



1.1

The universal one

Industrial device for accurate imprint

Print module		PX Q4.3		PX Q4	
Printable resolution	dpi	203	300	300	600
Print speed	up to mm/s	300	300	300	150
Print width	up to mm	104	108.4	105.7	105.7



1.2

The wide one

Suitable for Odette and UCC labels

Print module		PX Q6.3	
Printable resolution	dpi	203	300
Print speed	up to mm/s	250	250
Print width	up to mm	168	162.6

Directions of label transfer



All the print modules are provided as left-hand and right-hand versions. As for printable resolutions, PX Q users can choose from 300 and 600 dpi, the PX Q4.3 and PX Q6.3. offer 203 and 300 dpi.

Details

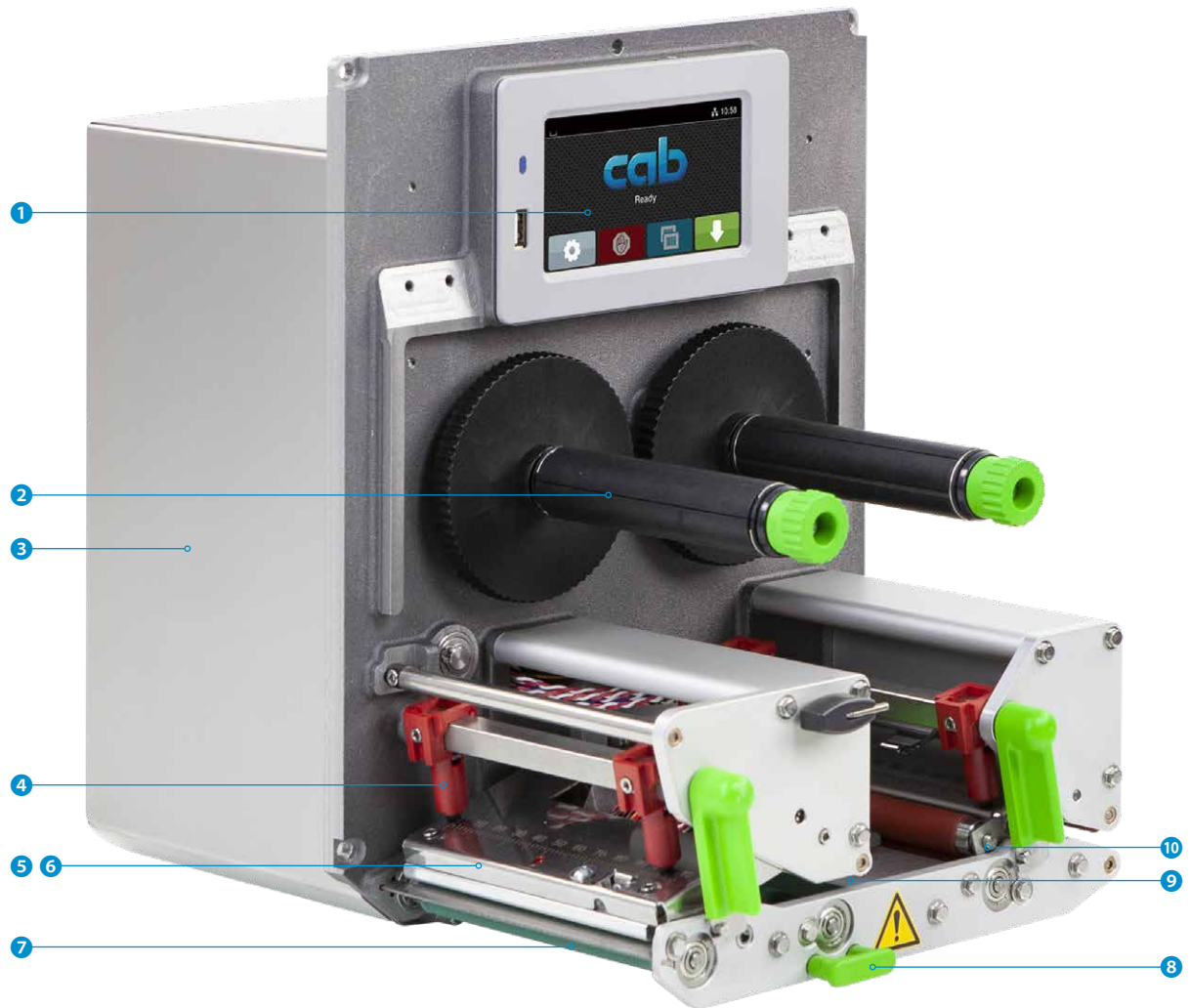

1 Operation panel

Operating the device is intuitive and simple with the help of self-explanatory symbols to configure settings

2 Ribbon holder

Three-part tightening axles enable the ribbon to be replaced quickly and easily.

3 Rugged metal chassis

made of cast aluminum; basis to assemble all units

4 Plungers

One plunger is fixed on the inner side. A second one is moved that far to the label margin, until a good print image evokes.

5 Print head

All print heads are freely interchangeable at equal width. Easy replacement

6 Automatic ribbon saving (option)

The print head is lifted during label feed and the ribbon is stopped.

7 Print roller removal

It can be easily removed or inserted in the cases of cleaning or wear.

8 Simple replacement of materials

Label materials are inserted until lateral stop. The print head and wipe-down rollers are locked by levers.

9 Label sensor

A gap sensor or a reflective sensor position the imprint precisely on the label and detect the end of the material.

10 Material backfeed

After a label has been peeled off, the next one can be retracted to behind the print line. By this, the whole label can be printed and adhesive leaking is avoided during a longer pause. In case sensitive materials are processed and to prevent the ribbon from wrinkling, the print head can be lifted.

Imprint accuracy







The smaller a label, the higher are the requirements on the imprint accuracy. With the help of the adjustable slip correction, print offset can be reduced by ± 0.2 mm.

Operation panel

Operating the device is intuitive and simple with the help of self-explanatory symbols to configure settings.

- 1 **LED signal:** Power ON
- 1 **Status bar:** data reception, record data stream, ribbon pre-warning, SD memory card / USB memory stick plugged, WLAN, Ethernet, USB slave, time
- 3 **Printer status:** Ready, Pause, number of labels printed in a print job, label in peel-off position, awaiting external start signal
- 4 **USB slot** to connect the Service Key or a memory stick, in order to transfer data to the IFFS memory

5 Operation

-  Print label
-  Jump to menu
-  Reprint last label
-  Interrupt and continue print job
-  Stop and delete all print jobs
-  Label feed

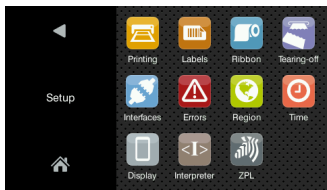

Setup options

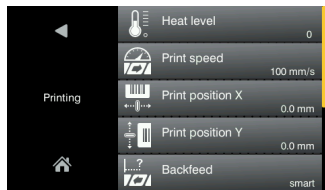

Print parameters

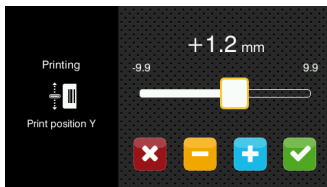

Print position Y

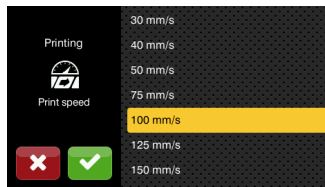

Print speeds

Depending from the orientation of assembly, display is either in landscape or portrait mode.



Printer rotated by 90°



Video tutorials

External operation panel

If the operation panel of a printer cannot be accessed, an additional external one can be plugged.

Same functionality as on the printer

Landscape or portrait mode

Operability as desired on the external operation panel or on the printer

Printer connectivity: USB 2.0 Hi-Speed device

- 1 **LED:** Power ON
- 2 **USB port** to plug a service key or a memory stick, to transfer data to the IFFS memory
- 3 **Connecting USB cable** for power supply cab provides specified cables. Lengths are 1.8 m to 16 m.



Print heads



All print heads are freely interchangeable at equal width. They are automatically detected and calibrated by the CPU. The print distance to the locating edge can be adjusted.

Major data such as running performance, maximum operating temperature and heat energy are directly stored in the print head. The data can be read at the plant.

Print heads for print module PX Q4 - 300, 600 dpi
 providing sharp-edged print images
 suitable for small fonts and graphics on typeplates
 suitable for markings on materials with high energy needs

Print heads for print modules PX Q4.3 and PX Q6.3 - 203, 300 dpi
 durable; suitable for rough surroundings and thermal direct printing

Print rollers



Two types of material:

Print rollers DR

Coating: synthetic rubber

They suit for highly accurate imprint and are provided as standard.

Print rollers DRS

Coating: silicone

They have an extra long service life at a higher imprint tolerance.

Interfaces

- 1 Slot to connect a **SD memory card**
- 2 **2 x USB Host** to connect a Service Key, an USB stick, a keyboard, an USB WLAN stick, external operation panel
- 3 **USB 2.0 Hi-speed device** to connect a PC
- 4 **Ethernet 10/100 Mbit/s**
- 5 **RS232C 1,200 to 230,400 baud/8 bit**

Digital I/O interfaces; compliant with IEC/EN 61131-2, type 1+3
 All inputs and outputs are galvanically isolated and protect from reverse polarity. In addition, outputs are short circuit protected.

- 6 **Digital I/O interface 24 VDC;** 25 pin SUB-D socket connector

Inputs PNP

Start printing
 Reprint
 Delete print job
 Label removed
 Stop printing
 Label feed
 Pause
 Reset

Outputs PNP, NPN

Device ready
 Print data available
 Label in peel-off position
 Paper feed ON
 Pre-warning to ribbon ending
 End of ribbon and/or end of labels
 Printer error
 Printing started

- 7 **Digital I/O interface 5 VDC;** 15 pin SUB-D socket connector

Inputs PNP

Label feed
 Reprint
 Start printing
 Pause
 Delete print job

Outputs PNP, NPN

Pre-warning to ribbon ending
 End of ribbon
 End of labels
 Print data available
 End of printing
 Printer error

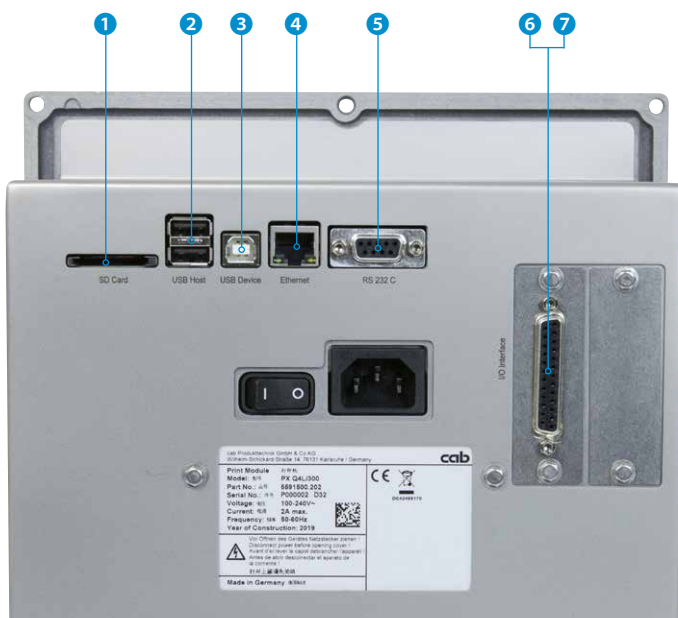

For more interfaces see "Options" on page 6

Options are parts or units to perform special functions. They are assembled to a printer in addition to or instead of standards.

If order implies options be assembled ex factory, the part numbers of such printers and options are added by .250. Options delivered separately are added by .001.

Pos.	Designation	1.1	1.2	1.3	.250	.001
		PX Q4.3	PX Q4	PX Q6.3		
3.1	Automatic ribbon saving	<input type="checkbox"/>	<input type="checkbox"/>	<input type="checkbox"/>	●	-
3.2	Print roller DRS	<input type="checkbox"/>	<input type="checkbox"/>	<input type="checkbox"/>	●	●
3.3	Digital I/O interface 24 VDC	<input type="checkbox"/>	<input type="checkbox"/>	<input type="checkbox"/>	●	●
3.4	Digital I/O interface 5 VDC	<input type="checkbox"/>	<input type="checkbox"/>	<input type="checkbox"/>	●	●
3.5	2 port Ethernet Switch 10/100 Mbit/s	<input type="checkbox"/>	<input type="checkbox"/>	<input type="checkbox"/>	●	●
3.6	Interface for plugging an external label sensor	<input type="checkbox"/>	<input type="checkbox"/>	<input type="checkbox"/>	●	●



Automatic ribbon saving

Use is recommended in cases of at least 60 mm unprinted area on a label. While labels are fed, the print head is lifted and the ribbon stopped, resulting in less material consumption.



Print roller DRS

providing a silicone coating. Product life is extra long, taken a higher print offset into account on a label.



Digital I/O interface 24 VDC

25 pin SUB-D socket connector



Digital I/O interface 5 VDC

15 pin SUB-D socket connector



2 port Ethernet Switch 10/100 Mbit/s

to connect another terminal device in a joint network. Signals are looped through













Interface for plugging an external label sensor

M12 plug, 5 pins, a-coded
Plug-compatible with CEON and other sensors based on PNP and 24 V

Accessories

Accessorial products are plugged or screwed to a printer by the customer.

Pos.	Designation	1.1	1.2	1.3
		PX Q4.3	PX Q4	PX Q6.3
2.1	SD memory card	<input type="checkbox"/>	<input type="checkbox"/>	<input type="checkbox"/>
2.2	USB memory stick	<input type="checkbox"/>	<input type="checkbox"/>	<input type="checkbox"/>
2.3	USB WLAN stick	<input type="checkbox"/>	<input type="checkbox"/>	<input type="checkbox"/>
2.4	USB WLAN stick including a rod antenna	<input type="checkbox"/>	<input type="checkbox"/>	<input type="checkbox"/>
2.5	USB Bluetooth adapter	<input type="checkbox"/>	<input type="checkbox"/>	<input type="checkbox"/>
2.6	I/O interface connector SUB-D, 25 pins	<input type="checkbox"/>	<input type="checkbox"/>	<input type="checkbox"/>
2.7	I/O interface connector SUB-D, 15 pins	<input type="checkbox"/>	<input type="checkbox"/>	<input type="checkbox"/>
2.8	External operation panel	<input type="checkbox"/>	<input type="checkbox"/>	<input type="checkbox"/>
	Connecting USB cable	<input type="checkbox"/>	<input type="checkbox"/>	<input type="checkbox"/>
2.9	Label selection - I/O box	<input type="checkbox"/>	<input type="checkbox"/>	<input type="checkbox"/>
2.10	Connecting RS232 C cable	<input type="checkbox"/>	<input type="checkbox"/>	<input type="checkbox"/>
2.11	Interface cover unit	<input type="checkbox"/>	<input type="checkbox"/>	<input type="checkbox"/>

2.1		SD memory card	<p>2.8</p>  <p>External operation panel If the operation panel of a printer cannot be accessed, an additional external one can be plugged. Same functionality as on the printer Landscape or portrait mode Operability as desired on the external operation panel or on the printer</p> <p>Printer connectivity: USB 2.0 Hi-Speed device cab provides specified connecting USB cables for power supply. Lengths are 1.8 m to 16 m.</p>
2.2		USB memory stick	
2.3		USB WLAN stick 2.4 GHz 802.11b/g/n hotspot or infrastructure mode	
2.4		USB WLAN stick including a rod antenna to extend the range of operation 2.4 GHz 802.11b/g/n + 5 GHz 802.11a/n/ac hotspot or infrastructure mode	
2.6		I/O interface connector SUB-D, 25 pins All control signals can be attached to the I/O interface using clamping screws.	
2.7		I/O interface connector SUB-D, 15 pins All control signals can be attached to the I/O interface using clamping screws.	
2.9		Label selection - I/O box A maximum of 16 different labels can be selected from a memory card by a master control unit, e.g. PLC.	
2.10		Connecting RS232 C cable 9/9 pins, 3 m	
2.11		Interface cover unit to protect from humidity and contamination	

Device functionality and compliance with CE standards are only guaranteed using accessories provided or recommended by cab.



Technical data

● typical ■ standard □ option

Print module		Type	PX Q4.3		PX Q4		PX Q6.3		
Printing method	Thermal transfer		●	●	●	●	●	●	
	Thermal direct		●	●	-	-	●	●	
Printable resolution	dpi		203	300	300	600	203	300	
Print speed	up to mm/s		300	300	300	150	250	250	
Print width	up to mm		104	108.4	105.7	105.7	168	162.6	
Print length	up to mm		13,500	6,000	6,000	1,500	9,000	4,000	
Direction of label transfer			L to the left or R to the right						
Print distance to locating edge	for L and R mm		1	1	1	1	1	1	
	with automatic saving L and R mm		3.2/2.6	1/0.4	2/2	2/2	1.2/1.2	3.9/3.9	
Material									
Labels			Paper, plastics such as PET, PE, PP, PI, PVC, PU, acrylate, Tyvec						
Labels ¹⁾	Width	mm	10 - 116		10 - 116		50 - 174		
	Height without backfeed	from mm	6		6		12		
	Height with backfeed	from mm	12		12		25		
	Thickness	up to mm	0.60		0.60		0.60		
Liner material	Width	mm	25 - 120		25 - 120		50 - 178		
	Thickness	mm	0.03 - 0.16						
Ribbon ²⁾	Ink side		outside or inside						
	Roll diameter	up to mm	90						
	Core diameter	mm	25.4						
	Variable length	up to m	600						
	Width	mm	25 - 114		25 - 114		50 - 170		
Automatic saving			□		□		□		
Print module dimensions and weights									
Width x Height x Depth		mm	245 x 300 x 333				245 x 300 x 393		
Weight		kg	11.5				12		
Label sensor with position indication									
Gap sensor		for	labels, punch marks or print marks and end of material						
Reflective sensor		reflex from below	for	print marks on non-transparent liner materials and end of material					
Distance of sensor to locating edge		mm	4 - 60		4 - 60		4 - 60		
Material passage		mm	2						
Electronics									
Processor 32 bit clock rate		MHz	800						
Main memory (RAM)		MB	256						
Data memory (IFFS)		MB	50						
Slot to connect a SD memory card (SDHC, SDXC)			■						
Battery for time and date, real-time clock			■						
Data memory when power is switched off (e.g. serial numbering)			■						
Interfaces									
RS232C 1,200 to 230,400 baud/8 bit			■						
USB 2.0 Hi-speed device to connect a PC			■						
Ethernet 10/100 Mbit/s IPv4 and IPv6			LPD, RawIP printing, SOAP web service, OPC UA, WebDAV DHCP, HTTP/HTTPS, FTP/FTPS, TIME, NTP, Zeroconf, SNMP, SMTP, VNC						
2 x USB host on the control panel, 2 x USB host on the back of a unit			Service Key, USB stick, USB WLAN stick, USB WLAN stick with a rod antenna, keyboard, barcode scanner, external control panel						
Digital I/O interface 24 VDC with 8 inputs and 9 outputs			□						
Digital I/O interface 5 VDC with 5 inputs and 6 outputs			□						
2-Port Ethernet Switch 10/100 Mbit/s			□						
Operating data									
Power supply			100-240 VAC, 50/60 Hz, PFC						
Power consumption			Standby < 10 W / typical 100 W / max. 200 W						
Temperature / humidity	Operation		+5 - 40°C / 10 - 85 %, not condensing						
	Stock		0 - 60°C / 20 - 85 %, not condensing						
	Transport		-25 - 60°C / 20 - 85 %, not condensing						
Approvals			CE, UKCA, FCC Class A, ICES-3, cULus, CB, RCM						

¹⁾ Limitations may apply to small labels, thin materials or strong adhesives. Critical applications need to be tested.

²⁾ The ribbon should at least correspond with the width of the liner material.

Technical data

■ standard □ option

Operation panel		
Colored LCD touch display	Screen diagonal	" 4.3
		Resolution Width x Height px 480 x 272
Setup options		
Print Labels Ribbon Peel-off Apply Interfaces Error	Region: - Language - Country - Keyboard - Time zone Time Display: - Brightness - Power saving mode - Orientation Interpreter	
Status bar		
Data reception Record datastream Ribbon warning SD memory card plugged in USB memory stick plugged in	WLAN Ethernet USB slave Time	
Monitoring		
Ribbon Labels Print head Voltage	Direction of winding Pre-warning End of material End of material Temperature open	Print roller for backfeed open
Test routines		
System diagnostics	on start-up, including print head detection	
Information display, test printout, analysis	Status printout Fonts list List of devices WLAN status Record print data on memory card	Test grid Label profile List of events Monitor mode
Status reports	- Printout of device settings, e.g. print lengths and service hours - Device status request by software command - Display of, e.g., network errors, no links, barcode errors, periphery errors, etc.	
Fonts		
Font types provided internally	5 Bitmap fonts: 12 x 12 dots 16 x 16 dots 16 x 32 dots OCR-A OCR-B	7 vector fonts: AR Heiti Medium GB-Mono CG Triumvirate Condensed Bold Garuda HanWangHeiLight Monospace 821 Swiss 721 Swiss 721 Bold
to be stored	TrueType fonts	
Character sets	Windows-1250 to -1257 DOS 437, 737, 775, 850, 852, 857, 862, 864, 866, 869 EBCDIC 500 ISO 8859-1 to -10 and -13 to -16 WinOEM 720 UTF-8 MacRoman DEC MCS KOI8-R Western European Eastern European Chinese simplified Chinese traditional Thai	
		Cyrillic Greek Latin Hebrew Arabic

cab uses free and Open Source Software in its products.
For information see www.cab.de/opensource

Fonts		
Bitmap fonts	Widths and heights 1 - 3 mm Zoom factors 2 to 10 Orientations 0°, 90°, 180°, 270°	
Vector-/TrueType fonts	Widths and heights 0,9 - 128 mm Continuous zoom Orientation 360° in steps of 1°	
Font styles	bold, italic, underlined, outline, inverse - depending from the font types	
Character spacing	variable or monospace for fixed character spacings	
Graphics		
Graphic elements	Lines, arrows, rectangles, circles, ellipses - filled or filled with fading	
Graphic formats	PCX, IMG, BMP, TIF, MAC, GIF, PNG	
Codes		
1D barcodes (linear)	Code 39, Code 93 Code 39 Full ASCII Code 128 A, B, C EAN 8, 13 EAN/UCC 128/GS1-128 EAN/UPC Appendix 2 EAN/UPC Appendix 5 FIM HIBC	Interleaved 2/5 Ident and routing code of Deutsche Post Codabar JAN 8, 13 MSI Plessey Postnet RSS 14 UPC A, E, E0
2D and stacked codes	DataMatrix DataMatrix Rectangle Extension QR code Micro QR code rMQR code GS1 QR code GS1 DataMatrix GS1 Digital Link (QR and DataMatrix) PDF 417 Micro PDF 417 UPS MaxiCode GS1 DataBar Aztec Codablock F Dotcode RSS 14 truncated, limited, stacked, stacked omni-directional All codes are variable in terms of height, modular width and ratio; orientations 0°, 90°, 180°, 270° check digit, plain text printout and start / stop code are options depending from the type of code	
Software		
Label software	cablabel S3 Lite cablabel S3 Viewer cablabel S3 Pro cablabel S3 Print	■ ■ □ □
Running also with	CODESOFT Loftware Spectrum NiceLabel BarTender	
Stand-alone operation	■	
Windows printer drivers certified WHQL for	Windows 10 Windows 11	Server 2016 Server 2019 Server 2022
Apple printer drivers	Mac OS X 10.6 or any later release	
Linux printer drivers	CUPS 1.2 or any later release	
Programming	JScript printer language abc Basic Compiler ZPL II (Datastream be tested in advance)	■ ■ □
Integration	SAP Database Connector	■ ■
Administration	Printer control Configuration in Intranet and Internet	■ ■

cablabel S3 software

Designing, printing, administrating

cablabel S3 opens up the full potential of cab devices. First of all, the label must be designed. cablabel S3 is of a modular design which makes it adaptable to requirements step by step. To support functions like native JScript programming, elements such as the JScript Viewer are embedded as plug-ins. The designer user interface and the JScript code are synchronized in real time. Special functions like the Database Connector or barcode testers can be integrated.



For further information see
www.cab.de/en/cablabel

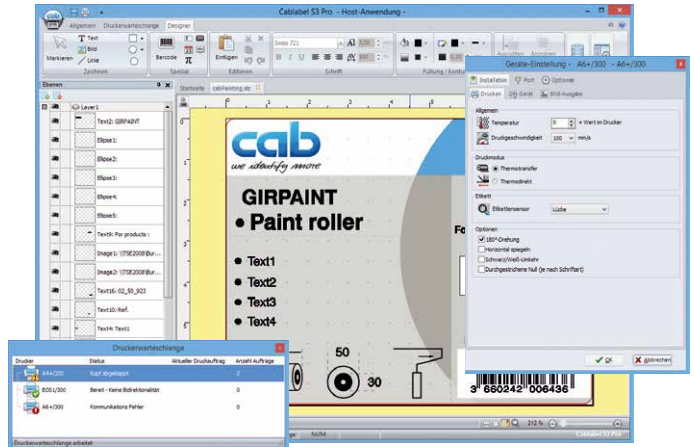

Stand-alone printing

A printer can select and print labels even when the system is disconnected from a host.

Labels are designed using software such as cablabel S3 or a text editor on a PC. Label formats, texts, graphics and data taken from a database are transferred to a memory card, a USB memory stick or the internal IFFS memory.

Only variable data are sent to the printer using a keyboard, a barcode scanner, scale or another host system and/or are recalled from a host by the Database Connector and printed.



OPC UA

The latest cab printers are ready to interact with machines and components of different manufacturers in industrial plants.

An OPC UA server and a client are part of the firmware.

The server enables a printer be configured and controlled. Dynamic print data can be edited using a defined programming interface.

The integral client enables reading data fields from other machines ready for OPC UA, as well as transferring data to a label. No additional software is needed.



Printer control

Drivers



cab provides drivers to control a printer with software other than cablabel S3.



Free download on www.cab.de/en/support



Programming



JScript

To control a printer, cab developed the embedded JScript programming language. Free manual download on www.cab.de/en/programming



abc Basic Compiler

An integral part of the firmware, it adds to JScript in terms of programming a printer before data are edited for processing. For example, external printer languages can be replaced without intervening in the print job in process. Data may be transferred also from other systems, such as scales, barcode scanners or PLC.

Connecting to SAP®

Labels can be printed from SAP¹⁾ on cab devices and systems. There are various methods:

- Printing with SAPscript
- Printing with SmartForms
- Printing with Adobe Interactive Forms

See instructions in detail on www.cab.de/en/sap

¹⁾ SAP and associated logos are trademarks or registered trademarks of SAP SE

Printer administration



Configuration on the Intranet / Internet

cab printers integrate a HTTP and FTP server. A printer can be controlled and configured, firmware updated and memory cards managed using a standard web browser or FTP client. Administrators and operators are notified of states, warnings and errors via email or datagrams, based on a SNMP/SMTP client. Time and date are synchronized by a time server.

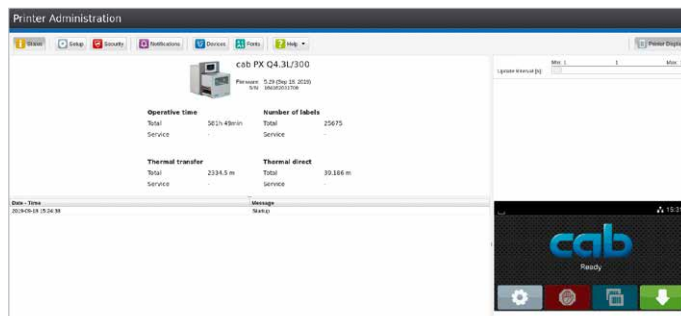



Database Connector

Printers connected to a network are enabled to access data directly from a central ODBC / OLEDB database and transfer it to a label. While labels are printed, data can be rewritten to the database..





PX Q delivery program

Print modules L

Pos.	Part no.	Designation
1.1		5591501 Print module PX Q4.3L/200 I/O 24 VDC
		5591502 Print module PX Q4.3L/300 I/O 24 VDC
		5591503 Print module PX Q4L/300 I/O 24 VDC
		5591504 Print module PX Q4L/600 I/O 24 VDC
1.2		5591505 Print module PX Q6.3L/200 I/O 24 VDC
		5591506 Print module PX Q6.3L/300 I/O 24 VDC







xxxxxxx.250 if PX Q provides options

Print modules R

Pos.	Part no.	Designation
1.1		5591510 Print module PX Q4.3R/200 I/O 24 VDC
		5591511 Print module PX Q4.3R/300 I/O 24 VDC
		5591512 Print module PX Q4R/300 I/O 24 VDC
		5591513 Print module PX Q4R/600 I/O 24 VDC
1.2		5591514 Print module PX Q6.3R/200 I/O 24 VDC
		5591515 Print module PX Q6.3R/300 I/O 24 VDC

xxxxxxx.250 if PX Q provides options

Options

Pos.	Part no.	Designation
3.1		5591794.250 Automatic ribbon saving 4L
		5591796.250 Automatic ribbon saving 6L
		5591795.250 Automatic ribbon saving 4R
		5591797.250 Automatic ribbon saving 6R
3.2		5954985.xxx Print roller DRS4
		5954979.xxx Print roller DRS6
3.3		6010372.xxx Digital I/O interface 24 VDC
3.4		6010512.xxx Digital I/O interface 5 VDC
3.5		6010520.xxx 2-Port Ethernet Switch 10/100 Mbit/s
3.6		5591816.xxx Interface for plugging an external label sensor

xxx - .250 assembled to the printer
.001 delivered separately

Scope of PX Q print module delivery	
	PX Q print module Power cable Type E+F, 1.8 m Connecting USB cable, 1.8 m Assembly instructions DE/EN/FR
Available online	
	Assembly instructions DE/EN/FR, Configuration manuals DE/EN/FR Service manuals DE/EN Spare parts lists DE/EN Programming manual EN Windows printer drivers certified WHQL for Windows 10 Server 2016 Windows 11 Server 2019 Server 2022 Apple Mac OS X printer drivers DE/EN/FR Linux printer drivers DE/EN/FR cablabel S3 Lite software and Viewer Database Connector (not active)
https://setup.cab.de/en	















Scopes of delivery, design and technical specifications correspond to the date of the printing. Subject to change. The data provided in the catalog do not represent any warranty or guarantee.



Information is available also on the Internet:
www.cab.de/en/pxq

PX Q delivery program



Accessories

Pos.	Part no.	Designation
2.1	 5977370	SD memory card
2.2	 5977730	USB memory stick
2.3	 5978912	USB WLAN stick 2.4 GHz 802.11b/g/n
2.4	 5977731	USB WLAN stick including a rod antenna 2.4 GHz 802.11b/g/n + 5 GHz a/n/ac
2.6	 5917651	I/O interface connector SUB-D, 25 pins
2.7	 5917652	I/O interface connector SUB-D, 15 pins
2.8	 6010186	External operation panel
	 5907718.850	Connecting USB cable, 1.8 m
	 5907730.850	Connecting USB cable, 3 m
	 5907750.850	Connecting USB cable, 5 m
	 5907760.850	Connecting USB cable, 11 m
	 5907765.850	Connecting USB cable, 16 m
2.9	 5948205	Label selection - I/O box
2.10	 5550818	Connecting RS232 C cable 9/9 pins, 3 m
2.11	 5591753	Interface cover unit

Label software

Pos.	Part no.	Designation
11.9	Bundle	cablabel S3 Lite (download on cab.de/en)
	5588001	cablabel S3 Pro, 1 WS
	5588100	cablabel S3 Pro, 5 WS
	5588101	cablabel S3 Pro, 10 WS
	5588150	cablabel S3 Pro, 1 add. licence
	5588151	cablabel S3 Pro, 4 add. licences
	5588152	cablabel S3 Pro, 9 add. licenses
	5588002	cablabel S3 Print, 1 WS
	5588105	cablabel S3 Print, 5 WS
	5588106	cablabel S3 Print, 10 WS
	5588155	cablabel S3 Print, 1 add. licence
	5588156	cablabel S3 Print, 4 add. licenses
	5588157	cablabel S3 Print, 9 add. licenses
	in preparation	cablabel S3 Print Server
11.10	9008486	Programming manual EN, printed copy

Wear parts

Pos.	Part no.	Designation	dpi
	5977382.001	Print head 4.3	200
	5977383.001	Print head 4.3	300
	5977444.001	Print head 4	300
	5977380.001	Print head 4	600
	5977386.001	Print head 6.3	200
	5977387.001	Print head 6.3	300
	5954180.001	Print roller DR4	
	5954245.001	Print rollerr DR6	

User languages

Language	Assembly instructions	Control panel	Windows driver	Service manual	cablabel S3
European Union					
Bulgarian		X	X		X
Danish	X	X	X		
German	X	X	X	X	X
Estonian		X	X		
Finnish		X	X		
French	X	X	X		X
Greek	X	X	X		
Italian	X	X	X		X
English	X	X	X	X	X
Croatian		X	X		
Latvian		X	X		
Lithuanian	X	X	X		
Dutch	X	X	X		
Polish		X	X		X
Portuguese		X	X		
Romanian		X	X		
Swedish		X	X		
Slovak	X	X	X		
Slovenian		X	X		
Spanish		X	X		X
Czech	X	X	X		X
Hungarian	X	X	X		
Europe (Non-EU)					
Macedonian		X	X		
Norwegian	X	X	X		
Russian	X	X	X		X
Serbian		X	X		
Turkish		X	X		
Asia					
Chinese (simplified)		X	X		X
Chinese (traditional)		X	X		X
Japanese		X	X		
Korean		X	X		X
Thai		x	X		
Middle East					
Arabian		X			
Persian		X			

Dimensions

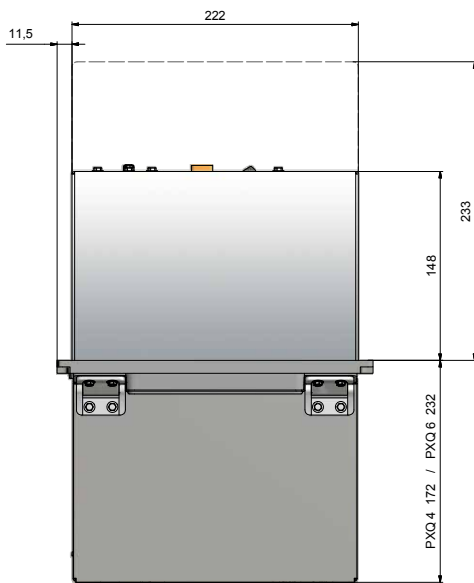
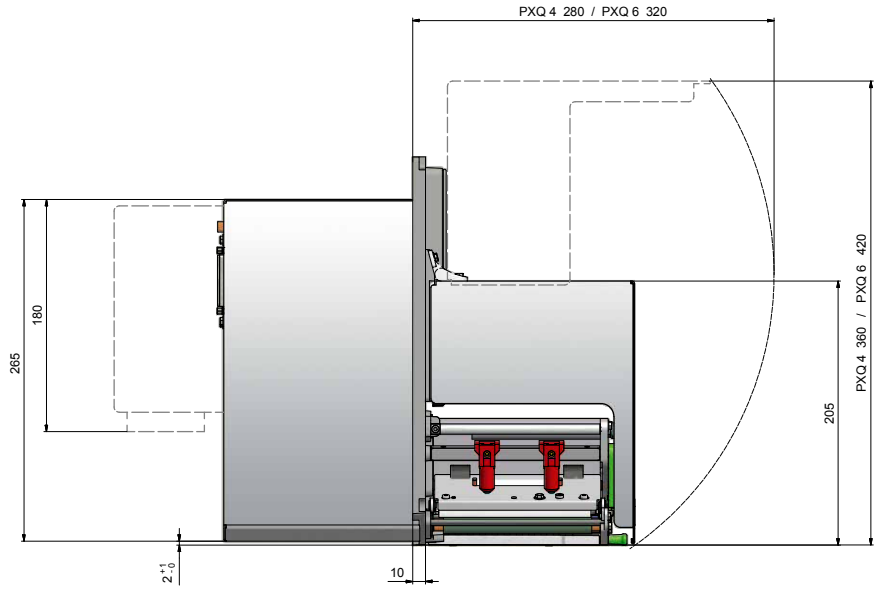
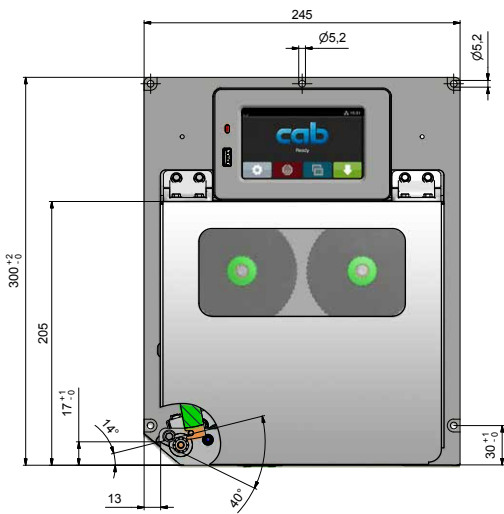

Print module weights	PX Q4.3	PX Q4	PX Q6.3
kg	11.5	11.5	12

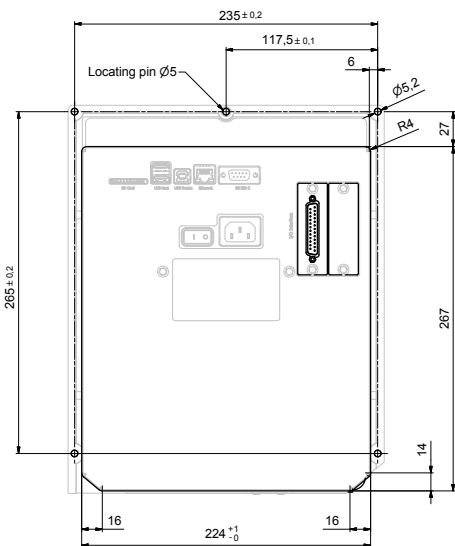

Overview of cab products

Label printers
MACH1, MACH2



Label printers
EOS 2



Label printers
EOS 5



Label printers
MACH 4S



Label printers
SQUIX 2



Label printers
SQUIX 4



Label printers
SQUIX 6.3



Label printers
SQUIX 8.3



Label printers
XD Q double-sided



Label printers
XC Q two-colored



Print and apply systems
HERMES Q



Print and apply systems
Hermes C two-colored

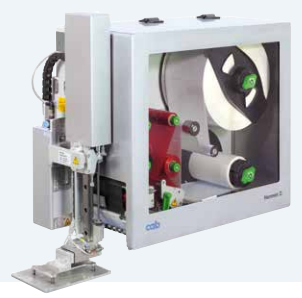

Tube labeling systems
AXON 1



Print modules
PX Q



Labels and ribbons



Label software
cablabel S3



Label dispensers
HS, VS



Labeling heads
IXOR



Marking lasers
XENO 4



Laser marking systems



Germany
cab Produkttechnik GmbH & Co KG
Karlsruhe
Phone +49 721 6626 0
www.cab.de

France
cab Technologies S.à.r.l.
Niedermodern
Phone +33 388 722501
www.cab.de/fr

USA
cab Technology, Inc.
Chelmsford, MA
Phone +1 978 250 8321
www.cab.de/us

Mexico
cab Technology, Inc.
Juárez
Phone +52 656 682 4301
www.cab.de/es

Taiwan
cab Technology Co., Ltd.
Taipei
Phone +886 (02) 8227 3966
www.cab.de/tw

China
cab (Shanghai) Trading Co., Ltd.
Shanghai
Phone +86 (021) 6236 3161
www.cab.de/cn

Singapore
cab Singapore Pte. Ltd.
Singapore
Phone +65 6931 9099
www.cab.de/en

South Africa
cab Technology (Pty) Ltd.
Randburg
Phone +27 11 886 3580
www.cab.de/za

cab // 820 distribution and service partners in more than **80** countries