

Status: 05/2020



Products need labeling
Print and apply systems



Hermes+
Made in Germany

Please note: Hermes+ was discontinued on December 31, 2019. Manufacture has been switched step by step to [HERMES Q](#). Repairs of Hermes+ are guaranteed at least until December 2025, so are spare parts deliveries.



Hermes+ for automatic printing and labeling in production lines

1.1



The slim one

for small labels

Label printer		Hermes+ 2	
Printable resolution	dpi	300	600
Print speed	up to mm/s	150	100
Print width	up to mm	54.2	57
Label roll outside diameter	mm	205 / 305	
Label width	up to mm	58	

In case of liner material with a width less than 24 mm, the label roll has to be guided by additional margin stops centered to the ribbon to achieve an accurate imprint. Kits are available on request.

1.2



The universal one

The best-selling industrial device with a wide range of accessories.

Label printer		Hermes+ 4			Hermes+ 4.3	
Printable resolution	dpi	203	300	600	203	300
Print speed	up to mm/s	250	250	100	250	250
Print width	up to mm	104	105.6	105.6	104	108.4
Label roll outside diameter	mm	205 / 305				
Label width	up to mm	114				

1.3



The wide one

for Odette, UCC and GS1 labels in applications in logistics

Label printer		Hermes+ 6	
Printable resolution	dpi	203	300
Print speed	up to mm/s	200	200
Print width	up to mm	168	162.6
Label roll outside diameter	mm	205 / 305	
Label width	up to mm	174	

Label reels and rolls

Hermes+ 2



Label reel diameter 205 mm

Hermes+ 2, 4, 6



Label roll diameter 205 mm

Hermes+ 2, 4, 6



Label roll diameter 305 mm

Directions of label demand

Hermes+ L



to the left

Hermes+ R



to the right

Hermes+ 2, 4, 6



For roll diameters up to 205 mm

Sample applications

PCB labeling



Package labeling



Container labeling



Details

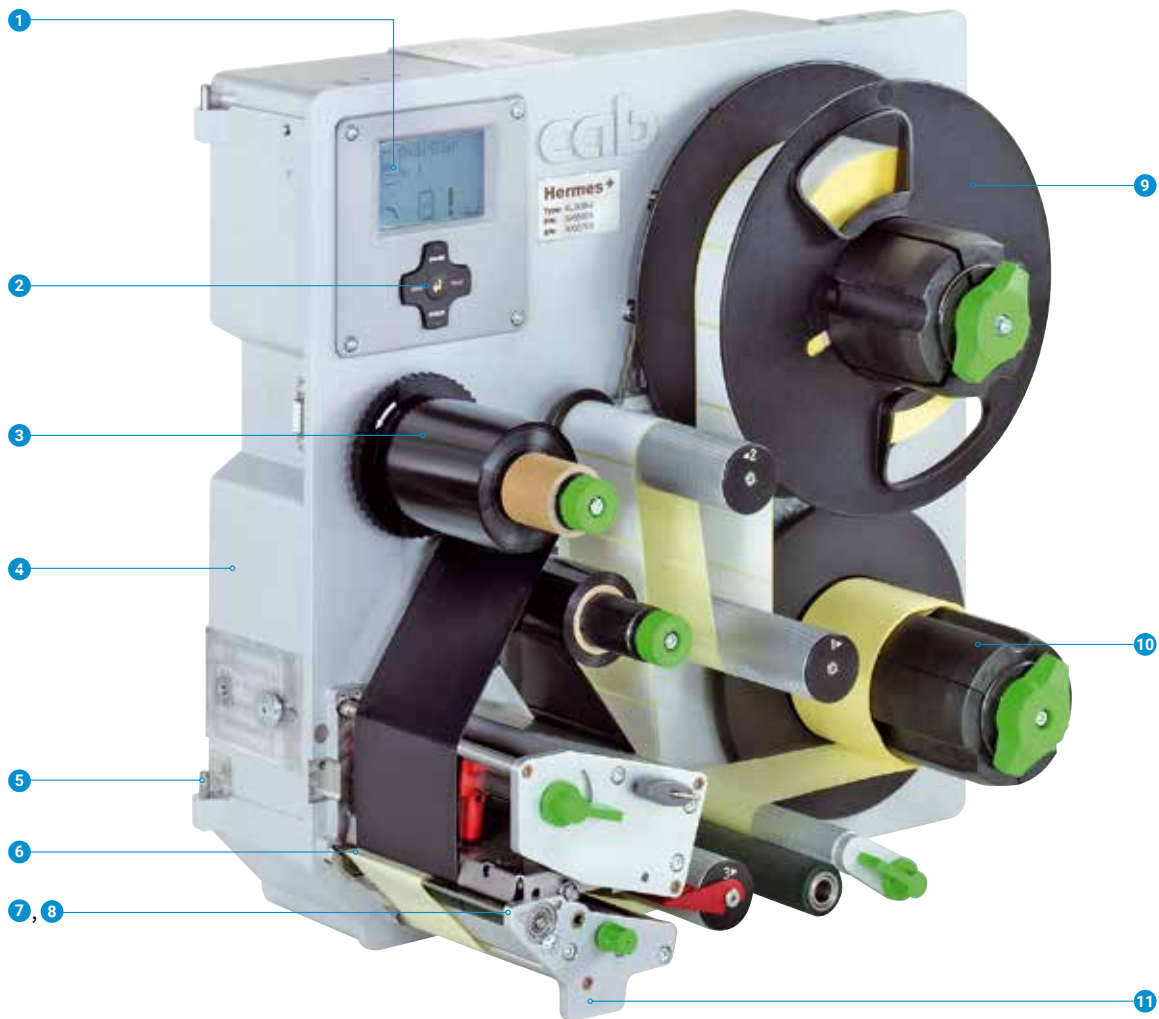

1 Large graphic display

White backlight provides optimum readability. Depending on the orientation of assembly, the display can be rotated in steps of 90°.

2 Navigator pad

allows simple, interactive menu control. Only applicable functions are displayed by the day and night design. In conjunction with the graphic display, navigation is made easy to understand.

3 Ribbon holder

Three-part tightening axles allows the ribbon to be exchanged quickly and easily.

4 Rugged metal chassis made of cast aluminum

Basis to assemble all components

5 Applicator assembly

The applicator is attached to hinge pins and can be easily removed for maintenance.

6 Print positioning

After inserting a new label roll, print positioning occurs automatically after few labels. The reference value remains even when the device is switched off.

7 Print head

To be exchanged in few steps. Adjustments and settings are easy to make.

8 Automatic ribbon saving

in case labels are printed only partially. Along blank areas, the print head is lifted and ribbon feed interrupts while label feed continues.

9 Label unwinder

The swing lever and the integral brake enable labels to be unwound with constant tension.

10 Liner rewinder

After all labels have been demanded, the liner of the label roll is fully rewound. The tightening axle allows the roll to be removed easily.

11 Feed system

The ball bearing transport rollers ensure highly accurate printing and a precise feed.

Direction of label demand

All Hermes+ devices with applicators are provided as left hand or right hand version.

Interfaces on the back of the device

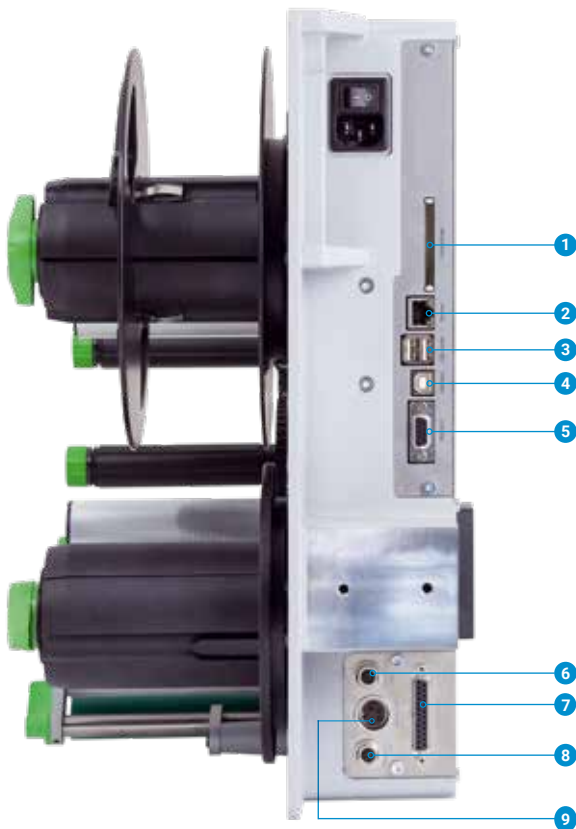

- 1 for a **CompactFlash Type I memory card**
- 2 **Ethernet 10/100 Mbit/s**
- 3 **2 x USB Master** to connect a Service Key, keyboard, barcode scanner, external operation panel
- 4 **USB 2.0 Slave** to connect a PC
- 5 **RS232C** 1,200 to 230,400 baud/8 bit
- 6 for the **ON/OFF valve of the compressed air regulation unit** to switch on or off compressed air supply
- 7 **Digital I/O interface**; 25 pin SUB-D socket connector
Compliant with IEC/EN 61131-2, type 1+3
all inputs and outputs are galvanically isolated and protected from reverse polarity. In addition, outputs are short circuit protected.

Inputs PNP

Start printing or applying
Reprint
Label feed
Delete print job
Pause
Label removed
Reset
Stop printing or applying
Print first label
Label rotation 90°
(Applicator 4214)

Outputs PNP; NPN on request

Ready status
Print data available
Paper feed ON
Pre-warning to end of ribbon
Pre-warning to end of label roll
Error signal end of ribbon
Error signal end of label roll
Label in demand position
Initial position / upper end
Labeling position / lower end
Common alarm

- 8 for an **external e-stop**
In conjunction with an ON/OFF valve plugged in, it allows compressed air supply to be interrupted in the event of danger.
- 9 for **warning light**

Examples of warning light assembly



Warning light

In addition to the display, it indicates the printer status.

Red Printer or applicator error
Yellow Pre-warning to end of ribbon
Green Device switched ON

Delivery includes a connecting cable and material to assemble to the chassis or the bracket.

Length of connecting cable 1 m

Technical data

● Typical ○ Possible ■ Standard □ Option

		1.1		1.2					1.3	
Label printer		Hermes+ 2		Hermes+ 4.3		Hermes+ 4			Hermes+ 6	
Printing method	Thermal transfer	●	●	●	●	●	●	●	●	●
	Thermal direct	●	-	●	●	○	○	-	●	●
Printable resolution	dpi	300	600	203	300	203	300	600	203	300
Print speed	up to mm/s	150	100	250	250	250	250	100	200	200
Print width	up to mm	54.2	57	104	108.4	104	105.6	105.6	168	162.6
Labels¹⁾										
Paper, PET, PE, PP, PI, PVC, PU, acrylate, Tyvec	on roll	●		●		●			●	
	on reel	○		-		-			-	
Thickness	mm	0.055 - 0.35								
Weight	g/m ²	60 - 160								
Width	mm	4 - 58		10 - 114					50 - 174	
Height	mm	4 - 200		8 - 320					25 - 320	
Liner material ²⁾ width	Roll	24 - 62		24 - 118					54 - 178	
	Reel	10 - 62		-					-	
Roll	Outside diameter	up to mm		205 / 305						
	Core diameter standard	mm		76		76			76	
	adapter, option	mm		40 / 50		40 / 50			-	
Winding	outside or inside									
Ribbon³⁾										
Ink side	outside or inside									
Roll diameter	up to mm	80		80					80	
Core diameter	mm	25		25					25	
Variable length	up to m	500		500					500	
Width	mm	60		114					165	
Automatic saving		-		□					□	
Internal rewinder										
Outside diameter	up to mm	155 / 210								
Core diameter	mm	76								
Printer dimensions and weights										
Width	mm	207		260					320	
Height with label roll diameter	205 mm	mm		400						
	305 mm	mm		538						
Depth with label roll diameter	205 mm	mm		400						
	305 mm	mm		518						
Weight	kg	15		16					20	
Label sensor with position indication										
Gap sensor for	labels, punch marks or print marks in transparent materials and end of material									
Reflective sensor from below or top for	print marks in not transparent materials and end of material									
Distance sensor to locating edge	mm	2 - 26		2 - 47					2 - 47	
Electronics										
Processor 32 bit clock rate	MHz	266								
Main storage (RAM)	MB	64								
Data storage (IFFS)	MB Flash	8								
Slot for CompactFlash Type I memory card		■								
Battery for time and date, real-time clock		■								
Error signal		■								
Interfaces										
Centronics		□								
RS232C 1,200 to 230,400 baud/8 bit		■								
USB 2.0 Slave to connect a PC		■								
Ethernet 10/100 Mbit/s		LPD, RawIP printing, DHCP, HTTP, FTP, SMTP, SNMP, TIME, Zeroconf, SOAP web service, mDNS								
RS422/RS485 1,200 to 230,400 baud/8 bit		□								
2x USB Master for		external operation panel, keyboard, barcode scanner, Service Key								
Warning light		■								
Digital I/O interface		■								
Applicator		■								
External e-stop		■								
ON/OFF valve of compressed air regulation unit		■								

¹⁾ Limitations may apply to small labels, thin materials or strong adhesives. Critical applications need to be tested. ²⁾ In case of liner material with a width less than 24 mm, the label roll has to be guided by additional margin stops centered to the ribbon to achieve an accurate imprint. Kits are available on request.

³⁾ The ribbon should at least correspond with the width of the liner material.

Technical data

■ Standard □ Option

Operating data		
Power supply	100-240 VAC, 50/60 Hz, PFC	
Power consumption up to W	300	
Temperature / humidity	Operation	+5 - 40°C / 10 - 85 % not condensing
	Storage	0 - 60°C / 20 - 85 % not condensing
	Transport	-25 - 60°C / 20 - 85 % not condensing
Approvals	CE, FCC class A, CB, CCC, c UL	
Setup options		
	Time Date Analog and digital clock 25 languages System settings Print parameters Interfaces Safety	
Display information		
	Data reception Ethernet Memory in use Print head temperature Memory card access	
	Time Calendar abc debug Input buffer Ribbon supply	
Monitoring		
	End of ribbon End of label roll Print head open	
Test routines		
System diagnostics when	device is switched on; print head detection included	
Information display, status printout, analysis	Fonts list, type overview, WLAN status, label profile, test grid, monitor mode, PPP status	
Status reports	- Printout of system settings, for example print lengths and running times - System status request via software command - Information display of, for example, network error, missing link, barcode error, etc.	
Fonts		
Font types	5 bitmap fonts including OCR-A, OCR-B and 3 vector fonts Swiss 721, Swiss 721 Bold, Monospace 821 are provided internally, TrueType fonts may be stored	
Character sets	Windows 1250 to 1257, DOS 437, 737, 775, 850, 852, 857, 862, 864, 866, 869, EBC DIC 500, ISO 8859-1 to -10 and -13 to -16, WinOEM 720, UTF-8, Macintosh Roman, DEC MCS, K018-R All West and East European, latin, cyrillic, Greek, Hebrew and Arabic characters, Chinese and Thai are supported.	
Bitmap fonts	Size in width and height 1-3 mm Zoom factor 2 to 10 Orientation 0°, 90°, 180°, 270°	
Vector / TrueType fonts	Size in width and height 0,9-128 mm Variable zoom Orientation 360° in steps of 1°	
Font styles	Bold, italic, underlined, outline, inverse - depending on the font type	
Character spacing	Variable	

Graphics	
Graphic elements	Lines, arrows, rectangles, circles, ellipses - filled and filled with fading
Graphic formats	PCX, IMG, BMP, TIF, MAC, GIF, PNG
Barcodes	
Linear	Code 39, Code 93 Code 39 Full ASCII Code 128 A, B, C EAN 8, 13 EAN/UCC 128/GS1-128 EAN/UPC Appendix 2 EAN/UPC Appendix 5 FIM HIBC
	Interleaved 2/5 Ident- and Leitcode of Deutsche Post Codabar JAN 8, 13 MSI Plessey Postnet RSS 14 UPC A, E, E0
2D und Stacked	DataMatrix QR code PDF 417 Micro PDF 417 UPS MaxiCode GS1 DataBar Aztec Codablock F RSS 14 truncated, limited, stacked, stacked omni-directional EAN/GS1 DataMatrix
	All codes are variable as regards height, modular width and ratio; orientations 0°, 90°, 180°, 270° optional check digit, plain text printout and start / stop code depending on the type of code
Software	
Label software	cablabel S3 Lite cablabel S3 Viewer cablabel S3 Pro cablabel S3 Print
Running also with	CODESOFT NiceLabel BarTender
Stand-alone operation	
WHQL certified Windows printer drivers for	Windows Vista Windows 7 Windows 8 Windows 8.1 Windows 10
	Server 2008 Server 2008 R2 Server 2012 Server 2012 R2 Server 2016 Server 2019
Apple Mac OS X printer drivers	from version 10.6
Linux printer drivers	from CUPS 1.2
Programming	Printer language JScript abc Basic Compiler
Integration	SAP Database Connector
Administration	Printer control Configuration in Intranet and Internet Network Manager

Label software cablabel S3

Designing, printing, administrating

cablabel S3 opens up the full potential of cab devices.

First of all, the label must be designed. Only when it comes to printing it has to be decided whether the label shall be processed on a label printer, a print and apply or marker laser system. cablabel S3 is of a modular design which makes it adaptable to requirements step by step. To support functions like native JavaScript programming, elements such as the JavaScript Viewer are embedded as plug-ins. The designer user interface and the JavaScript code are synchronized in real time. Special functions like the Database Connector or barcode testers can be integrated. For further information see www.cab.de/en/cablabel

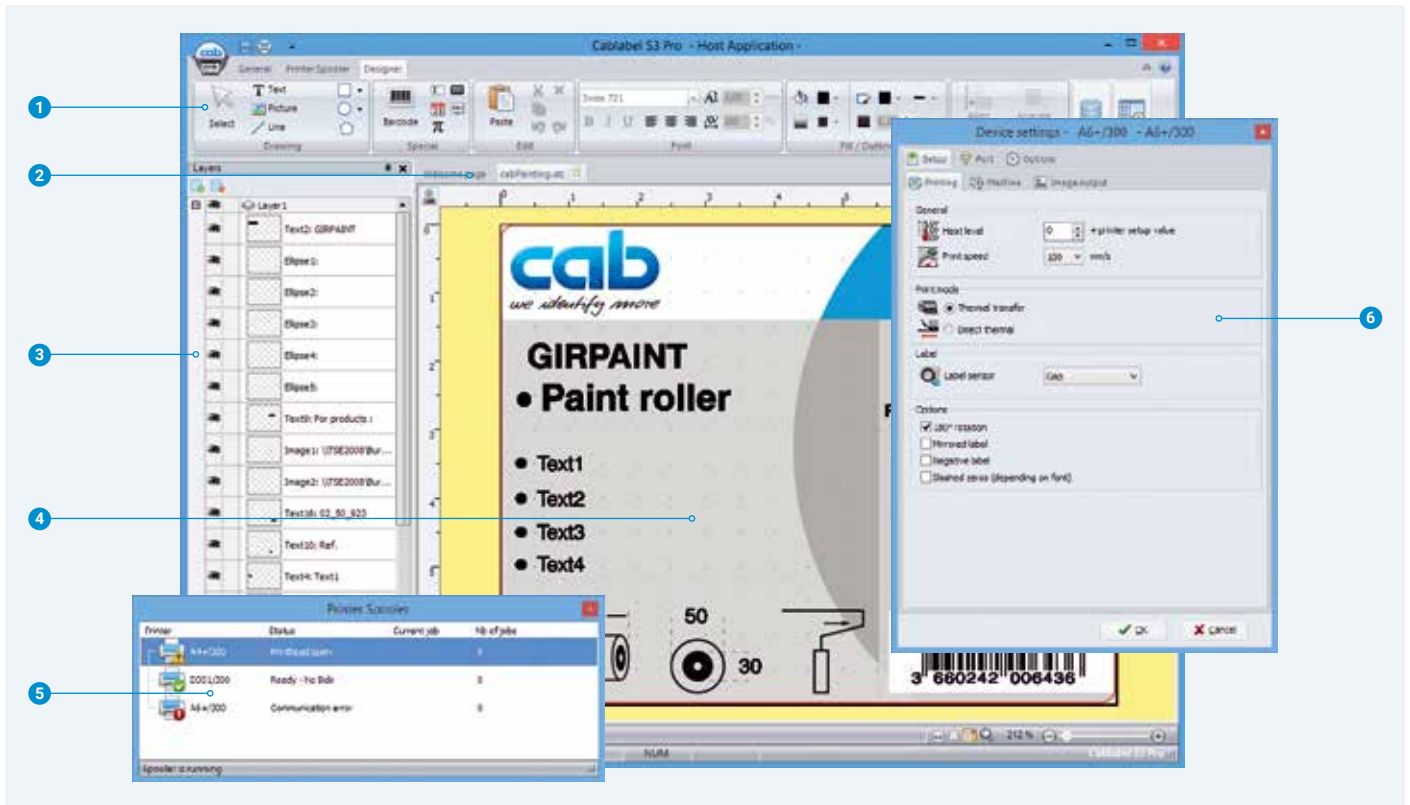

- 1 **Toolbar**
to create different label objects
- 2 **Tabs**
to quickly switch from one running label design to another
- 3 **Layers**
to administrate different label objects
- 4 **Designer**
simplifies the design and displays the label WYSIWYG
- 5 **Printer spooler**
to monitor all print jobs and the state of the printer
- 6 **Drivers**
for setting and the communication with devices

Printing in stand-alone operation

This operating mode is the printer's ability to select and print labels even when it is not connected connected to a host system.

The label has to be designed with a software such as cablabel S3 or by direct programming with a text editor on a PC. Label formats, texts, graphics as well as database contents are stored on a memory card, a USB memory stick or in the internal IFFS memory.

Only variable data are sent to the printer via a keyboard, a barcode scanner, scales or other host systems and/or recalled by the Database Connector from the host and printed.



Printer control

Drivers

To control the printer with a software other than cablabel S3, cab provides drivers in 32 / 64 bit for operating systems starting from Windows Vista, Mac OS 10.6 and Linux with CUPS 1.2.



Windows¹⁾ drivers

cab printer drivers are certified according to WHQL. They ensure optimum stability on the Windows operating system.



Mac OS X²⁾ drivers

cab provides CUPS-based printer drivers for Mac OS X applications.



Linux drivers³⁾

Linux drivers are CUPS-based.

Drivers are offered on the DVD delivered with the printer and for free download at www.cab.de/en/support

Programming



JScript

To control the printer, cab has developed the embedded programming language JScript. See manual for free download at www.cab.de/en/programming



abc Basic Compiler

In addition to JScript and as an integral part of the firmware, it allows advanced printer programming before data are sent to printout. For example, external printer languages can be replaced without interfering in the current print job. Also data from other systems such as a scale, a barcode scanner or PLC can be integrated.

Integration



Printer Vendor Program

As a partner in SAP's⁴⁾ Printer Vendor Program, cab has developed a replace method to enable easy control of a cab printer via SAPScript from SAP R/3. Only variable data are sent to the printer by the host. Pictures and fonts that had priorly been stored in the local memory (IFFS, memory card, etc.) are merged.

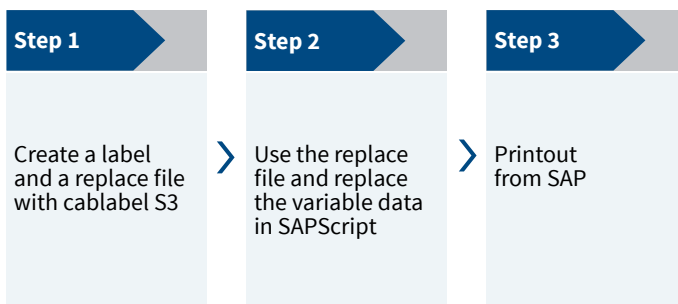

Printer administration



Configuration in Intranet and Internet

The HTTP and FTP server integrated in the printer via standard programs like a web browser or FTP clients allows printer control and configuration, firmware updates and memory card administration. Via email or SNMP, the SNMP and SMTP client datagram sends status, warning and error messages to administrators and users. Time and date are synchronized by a time server.



Network Manager

It is possible to simultaneously manage several printers within the network. Control, configuration, firmware updates, memory card administration, data synchronization and PIN administration are supported from one single location.



Database Connector

Printers connected to a network may directly access data from a central ODBC or OLEDB-ready database and print it on a label. While printing, data can be rewritten to the database.



¹⁾ Windows is a registered trademark of Microsoft Corporation

²⁾ MAC OS X is a registered trademark of Apple Computer, Inc.

³⁾ Only for device series SQUIX (except of SQUIX MT), MACH 4S, EOS, Hermes+ and PX

⁴⁾ SAP and all corresponding logos are trademarks or registered trademarks of SAP SE

Applicators

The Hermes+ have been designed for automatic printing and labeling in production lines. Various applicators are provided to roll, blow or tamp labels on products or packaging.

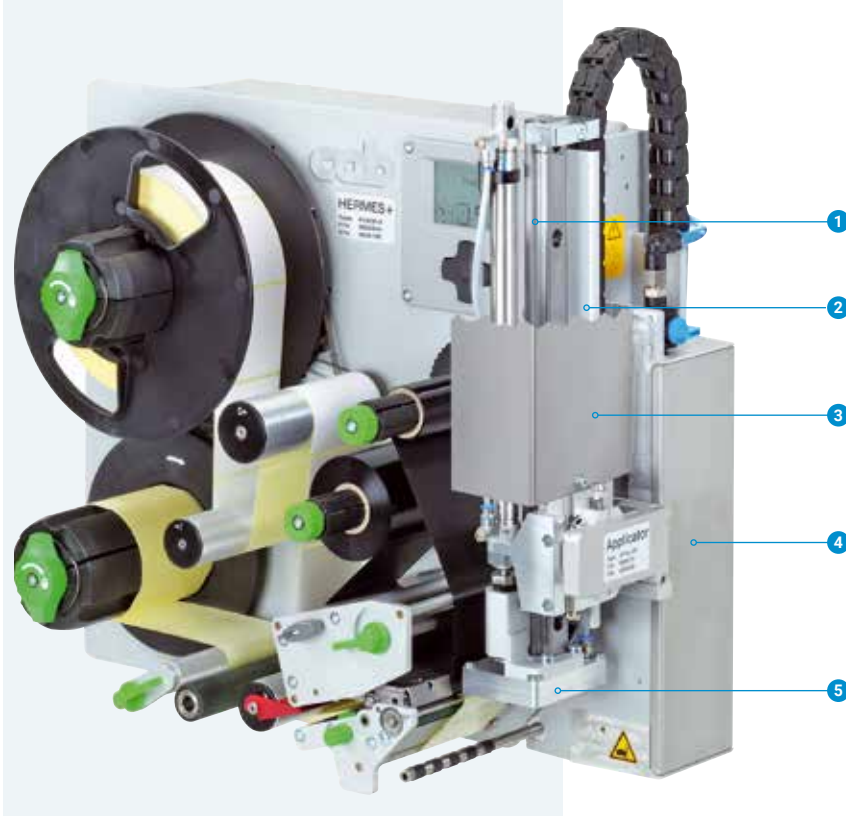

1 Long service life

Precise and low-wear linear guidance with a ball bearing chain

2 Variable product heights

The stroke cylinder allows labeling at different heights. It is available in lengths of 200, 300 and 400 mm as standard. Further lengths on request

3 Protective cover

The cylinder and the guide are protected by a cover as standard. Protective covers adapted to the product jig are offered for labeling workstations.

4 High process reliability

Supporting air, intake air and stroke speed are all adjustable. Monitoring is via sensors.

5 Real-time labeling

Applicators for small and large labels; Label heights from 4 to 250 mm and label widths from 4 to 174 mm can be processed.

6 Pivoting applicator

Access to the print mechanics in case of material exchange or maintenance is quick and easy.

Pressure reducing valve

By its installation, the pressure of the stroke cylinder contacting the product is reduced.



Overview of applicators and transfer modules

Applicator		Hermes+			Transfer module													
		2	4	6	Universal pad	Tamp pad	Tamp pad with damping layer	Tamp pad with label stop	Blow pad	Form pad	Universal pad spring-mounted	Tamp pad spring-mounted	Roll-on pad	Corner-wrap pad	Peel-off plate	Vacuum belt	Template	
		Order code			11	11	12	61	21	88	32	32	41	51	-	-	90	
5.1	Swing applicator	3214		-	F	F	F											
5.2	Stroke applicator	4114		-	F	F	F											
			4116	-	F	F	F											
5.3	Stroke turn applicator	4214		-	F	F	F											
5.4	Stroke applicator	4414		-	F	F	F											
5.5	Swing stroke applicator	4514		-														
5.6	Flag applicator		4712	-														

Product marking

5.7	Front side applicator	3014		-													
			3016	-													
5.8	Stroke applicator	4014			F												
			4016	-													
5.9	Stroke blow applicator	4614		-													
5.10	Demand module	5114		-													
5.11	Vacuum belt applicator	5314	5316														
		5414	5416	-													
5.12	Air jet box	6114		-													

Package marking

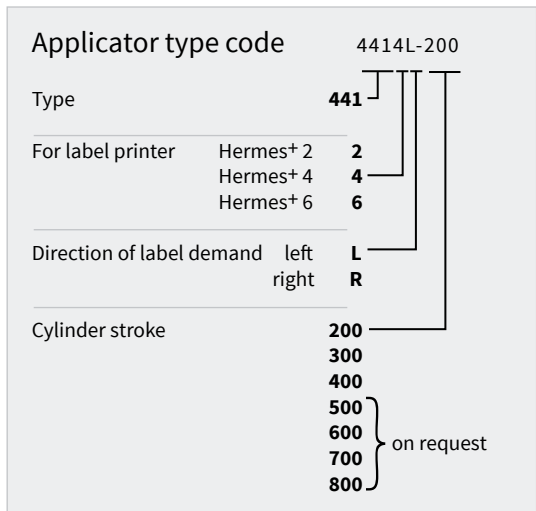

F Allows the tamp pad to immerse into the surface within the area of the label.

For detailed immersion depths see the applicator's technical data.

Product marking

Swing applicator 3214

for precise real-time labeling of very small to mid-sized labels. The labels are preferably applied on the side of the product.

The pad is positioned in front of the peel-off plate. The label is held during printing. A rotary cylinder swings in labeling position. The stroke cylinder applies the label on the product. Rotary angle and linear stroke are adjustable.

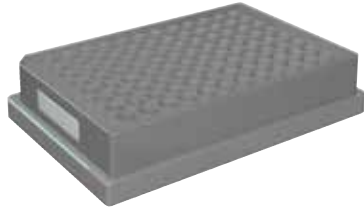

Accessories

5.13 Blow tube

5.14 Compressed air regulation unit

5.15 Compressed air regulation unit with ON/OFF valve

5.1



Tamp pad

Labels are precisely tamped on plain surfaces, even recessed.

Tamp pad with damping layer

With hard surfaces, the layer contributes to noise damping. The use gives also advantage with rough structures or minor unevenness.

Tamp pad with label stop

In case of small labels, the stop provides precise positioning on the product.

Blow pad

for pressure sensitive surfaces or when products are in motion. Air jet blows the labels onto the product.

5 to 10 mm distance to the product surface are set with a stop on the stroke cylinder.

			Tamp pad	Tamp pad with damping layer	Tamp pad with label stop	Blow pad
Technical data			3214 L/R 11 F	3214 L/R 12 F	3214 L/R 61 F	3214 L/R 2100
Label width	Hermes+ 2	mm	4 - 58	10 - 58	10 - 58	10 - 58
	Hermes+ 4	mm	10 - 114	10 - 114	10 - 114	10 - 80
Label height	Hermes+ 2	mm	5 - 80	8 - 80	5 - 80	10 - 80
	Hermes+ 4	mm	8 - 80	8 - 80	8 - 80	10 - 80
Product during labeling	not in motion				■	
	in motion		-	-	-	■
Product labeling	from the side				■	
Product height	fixed				■	
Product distance to peel-off plate	mm				250 - 280	
Horizontal linear guidance	mm				5 - 30	
Pivot angle					45° - 95°	
Immersion depth pad F	up to mm		30	30	30	-
Compressed air	bar				4.5	
Cycle time ¹⁾	approx. labels/min				20	

¹⁾ Calculated with label height 40 mm, print speed 100 mm/s

Product marking

Stroke applicators 4114, 4116

for precise real-time labeling of very small to mid-sized labels where installation is difficult. Labeling is possible from all sides.

The pad is positioned in front of the peel-off plate. The label is held during printing. A short stroke cylinder moves the pad horizontally to the labeling position. The stroke cylinder applies the label on the product. The length of the stroke cylinder defines the maximum product distance to the peel-off plate.



Accessories

5.13 Blow tube

5.14 Compressed air regulation unit

5.15 Compressed air regulation unit with ON/OFF valve

5.17 Pressure reducing valve

5.2

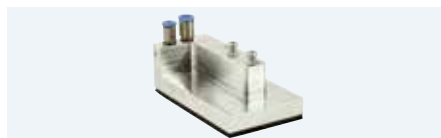

Tamp pad

Labels are precisely tamped on plain surfaces, even recessed.

Tamp pad with damping layer

With hard surfaces, the layer contributes to noise damping. The use gives also advantage with rough structures or minor unevenness.

Tamp pad with label stop

In case of small labels, the stop provides precise positioning on the product.

Blow pad

for pressure sensitive surfaces or when products are in motion. Air jet blows the labels onto the product.

5 to 10 mm distance to the product surface are set with a stop on the stroke cylinder.

			Tamp pad	Tamp pad with damping layer	Tamp pad with label stop	Blow pad
Technical data			4114, 4116 L/R 11 F	4114, 4116 L/R 12 F	4114, 4116 L/R 61 F	4114 L/R 2100
Label width	Hermes+ 2	mm	4 - 58	10 - 58	10 - 58	10 - 58
	Hermes+ 4	mm	10 - 114	10 - 114	10 - 114	10 - 114
	Hermes+ 6	mm	50 - 174	50 - 174	50 - 174	-
Label height	Hermes+ 2	mm	4 - 80	8 - 80	4 - 80	10 - 80
	Hermes+ 4	mm	8 - 80	8 - 80	8 - 80	10 - 80
	Hermes+ 6	mm	8 - 80	8 - 80	8 - 80	-
Product during labeling	not in motion				■	
	in motion		-	-	-	■
Product labeling	from top				■	
	from below				■	
	from the side				■	
Product height	fixed		-	-	-	■
	variable		■	■	■	-
Horizontal short stroke cylinder	mm			10		
Product distance to lower edge of device	at cylinder stroke 200	up to mm	135	135	135	140
	300	up to mm	235	235	235	240
	400	up to mm	335	335	335	340
Immersion depth pad F ¹⁾	up to mm	110	110	110	-	
Compressed air	bar			4.5		
Cycle time ²⁾	approx. labels/min			30		

¹⁾ In case the applicator's immersion depth is more than 25 mm, the cover of Hermes+ has to be adapted.

²⁾ Calculated with stroke 100 mm below device, label height 40 mm, print speed 100 mm/s

Product marking

Stroke applicators 4114, 4116

for precise real-time labeling of very small to mid-sized labels where installation is difficult. Labeling is possible from all sides.

The pad is positioned in front of the peel-off plate. The label is held during printing. A short stroke cylinder moves the pad horizontally to the labeling position. The stroke cylinder applies the label on the product. The length of the stroke cylinder defines the maximum product distance to the peel-off plate.

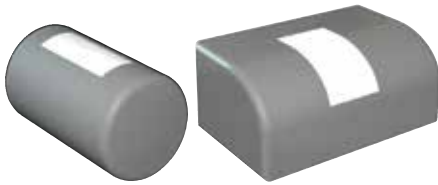

Accessories

- 5.13 **Blow tube**
- 5.14 **Compressed air regulation unit**
- 5.15 **Compressed air regulation unit with ON/OFF**
- 5.17 **Pressure reducing valve**

5.2



Form pad

Labels are applied precisely to cylindrical objects, oblique or curved surfaces. Curved form pads prevent from bubbling on very smooth and flat surfaces. With cylindrical objects, 200° maximum label wrapping is possible.

Technical data			Form pad
			4114, 4116 L/R 8800
Label width	Hermes ⁺ 2	mm	10 - 58
	Hermes ⁺ 4	mm	10 - 114
	Hermes ⁺ 6	mm	50 - 174
Label height		mm	8 - 80
Product during labeling	not in motion		■
Product labeling	from top		■
	from below		■
	from the side		■
Product height	variable		■
Horizontal short stroke cylinder	mm		10
Product distance to lower edge of device			
at cylinder stroke 200	up to mm		135
	300	up to mm	235
	400	up to mm	335
Compressed air		bar	4.5
Cycle time ¹⁾	approx. labels/min		20

¹⁾ Calculated with stroke 100 mm below the device, label height 40 mm, print speed 100 mm/s
In case the height of the form pad is more than 25 mm, the cover of Hermes⁺ has to be adapted.

Product marking

Stroke turn applicator 4214

for precise real-time labeling of very small to mid-sized labels where installation is difficult. Labeling is possible from all sides.

The pad is positioned in front of the peel-off plate. The label is held during printing. A rotary cylinder swings the pad horizontally up to 180° in labeling position. The stroke cylinder applies the label on the product. The length of the stroke cylinder defines the maximum product distance to the peel-off plate.



Accessories

- 5.13 **Blow tube**
- 5.14 **Compressed air regulation unit**
- 5.15 **Compressed air regulation unit with ON/OFF valve**
- 5.17 **Pressure reducing valve**



Tamp pad

Labels are precisely tamped on plain surfaces, even recessed.

Tamp pad with damping layer

With hard surfaces, the layer contributes to noise damping. The use gives also advantage with rough structures or minor unevenness.

Tamp pad with label stop

In case of small labels, the stop provides precise positioning on the product.

Blow pad

for pressure sensitive surfaces or when products are in motion. Air jet blows the labels onto the product.

5 to 10 mm distance to the product surface are set with a stop on the stroke cylinder.

			Tamp pad	Tamp pad with damping layer	Tamp pad with label stop	Blow pad
Technical data			4214 L/R 11 F	4214 L/R 12 F	4214 L/R 61 F	4214 L/R 2100
Label width	Hermes+ 2	mm	4 - 58	10 - 58	10 - 58	10 - 58
	Hermes+ 4	mm			10 - 80	
Label height	Hermes+ 2	mm	4 - 40	8 - 40	4 - 40	10 - 40
	Hermes+ 4	mm	8 - 40	8 - 40	8 - 40	10 - 40
Product during labeling	not in motion				■	
	in motion		-	-	-	■
Product labeling	from top				■	
	from below				■	
	from the side				■	
Product height	fixed		-	-	-	■
	variable		■	■	■	-
Horizontal rotary angle	90°, 0°				■	
Product distance to lower edge of device at cylinder stroke 200	up to mm		135	135	135	140
	300	up to mm	235	235	235	240
	400	up to mm	335	335	335	340
	Immersion depth pad F ¹⁾	up to mm	65	65	65	-
Compressed air	bar			4.5		
Cycle time ²⁾	approx. labels/min			20		

¹⁾ In case the applicator's immersion depth is more than 25 mm, the cover of Hermes+ has to be adapted.

²⁾ Calculated with stroke 100 mm below device, label height 40 mm, print speed 100 mm/s

Product marking

Stroke applicator 4414

for very precise real-time labeling of very small to mid-sized labels. Adjustability in x and y directions provides exact positioning on the product. Labeling is possible from all sides.

The pad is positioned in front of the peel-off plate. The label is held during printing. Two short stroke cylinders move the pad horizontally to the labeling position. The stroke cylinder applies the label on the product. The length of the stroke cylinder defines the maximum product distance to the peel-off plate.



Accessories

- 5.13 **Blow tube**
- 5.14 **Compressed air regulation unit**
- 5.15 **Compressed air regulation unit with ON/OFF valve**
- 5.17 **Pressure reducing valve**



Tamp pad

Labels are precisely tamped on plain surfaces, even recessed.

5.4



Tamp pad with damping layer

With hard surfaces, the layer contributes to noise damping. The use gives also advantage with rough structures or minor unevenness.

Tamp pad with label stop

In case of small labels, the stop provides precise positioning on the product.

			Tamp pad	Tamp pad with damping layer	Tamp pad with label stop
			4414 L/R 11 F	4414 L/R 12 F	4414 L/R 61 F
Technical data					
Label width	Hermes ⁺ 2	mm	4 - 58	10 - 58	10 - 58
	Hermes ⁺ 4	mm			
Label height	Hermes ⁺ 2	mm	4 - 80	8 - 80	4 - 80
	Hermes ⁺ 4	mm			
Product during labeling	not in motion			■	
Product labeling	from top			■	
	from below			■	
	from the side			■	
Product height	variable			■	
Horizontal short stroke cylinder	x direction mm			3 - 7	
	y direction mm			11 - 15	
Product distance to lower edge of device at cylinder stroke	200	up to mm		135	
	300	up to mm		235	
	400	up to mm		335	
Immersion depth pad F ¹⁾	up to mm			90	
Compressed air	bar			4.5	
Cycle time ²⁾	approx. labels/min			25	

¹⁾ In case the applicator's immersion depth is more than 25 mm, the cover of Hermes⁺ has to be adapted.

²⁾ Calculated with stroke 100 mm below device, label height 40 mm, print speed 100 mm/s

Product marking

Swing stroke applicator 4514

for real-time labeling on inner surfaces of profiles and pipes.
The exact position on the product is set with a stop on the stroke cylinder. Labeling is possible from all sides.

The pad is positioned in front of the peel-off plate. The label is held during printing. A rotary cylinder swings the pad to the labeling plane. The stroke cylinder moves the label to the demand position.



Accessories

5.13 **Blow tube**

5.14 **Compressed air regulation unit**

5.15 **Compressed air regulation unit with ON/OFF valve**

5.5



Blow pad

With 5 to 10 mm distance to the product surface, air jet blows the labels onto the product.

Technical data			Blow pad 4514 L/R 2100
Label width	Hermes+ 2	mm	10 - 58
	Hermes+ 4	mm	10 - 80
Label height		mm	10 - 60
Product during labeling	not in motion		■
Product labeling	from top		■
	from below		■
	from the side		■
Product height	fixed		■
Vertical pivot angle			120°
Distance lower edge of device to upper edge of label at cylinder stroke	200	up to mm	150 ²⁾
	300	up to mm	250 ²⁾
	400	up to mm	350 ²⁾
Compressed air		bar	4.5
Cycle time ¹⁾	approx. labels/min		20

¹⁾ Calculated with stroke 100 mm below device, label height 40 mm, print speed 100 mm/s

²⁾ depending on the label height

Product marking

Flag applicator 4712

for precise real-time labeling on round materials such as cables, hoses, pipes, etc. Labeling is possible from all sides.

The pad is positioned in front of the peel-off plate. The label is held during printing. It is moved by a stroke cylinder to the demand position. With the other cylinder, the label is guided around the round material via cam control. At first, it is precisely stuck at the ends and only then pressed to the round material. The length of the stroke cylinder defines the maximum product distance to the peel-off plate.

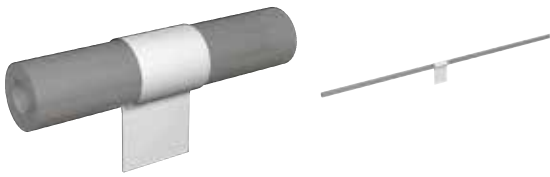

Accessories

- 5.13 **Blow tube**
- 5.14 **Compressed air regulation unit**
- 5.15 **Compressed air regulation unit with ON/OFF valve**

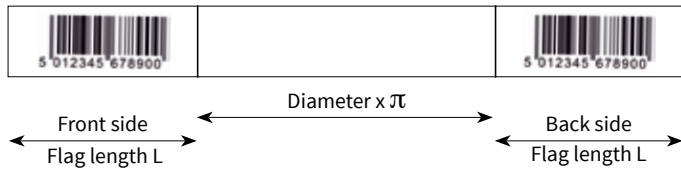

5.6

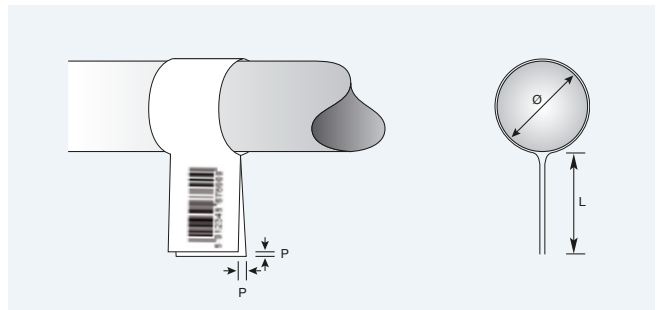

Technical data		Form pad
		4712 L 300
Label width Hermes+ 4	mm	60 - 100
Label height	mm	10 - 50
Diameter	mm	3 - 16
Product during labeling	not in motion	■
Product labeling	from top	■
	from below	■
	vertically rotated from the side	0 - 180° clockwise; others on request
Product height	fixed	■
Product distance to lower edge of device min. mm	at cylinder stroke 300	70
	up to mm	260
Immersion depth tongs	mm	55
Offset P	up to mm	1.0 ²⁾
Compressed air	bar	4.5
Cycle time ¹⁾	approx. labels/min	15

¹⁾ Calculated with print speed 100 mm/s

²⁾ depending on the label quality

Package marking

Front side applicators 3014, 3016

for real-time labeling on packaging in motion.
The labels are preferably applied to the front or back.
Labeling from top or from the side is possible.

The pad is positioned in front of the peel-off plate. The label is held during printing. The rotary cylinder applies the label on the packaging.
A sensor detects the packaging and, when labeling has finished, moves back the pivot arm and pad to their initial position.

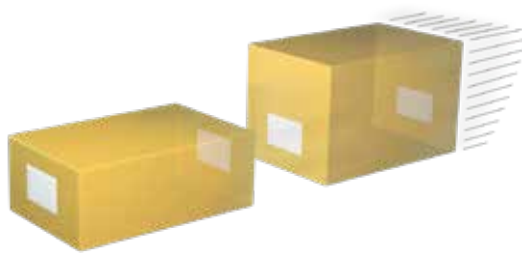

Accessories

- 5.13 **Blow tube**
- 5.14 **Compressed air regulation unit**
- 5.15 **Compressed air regulation unit with ON/OFF valve**

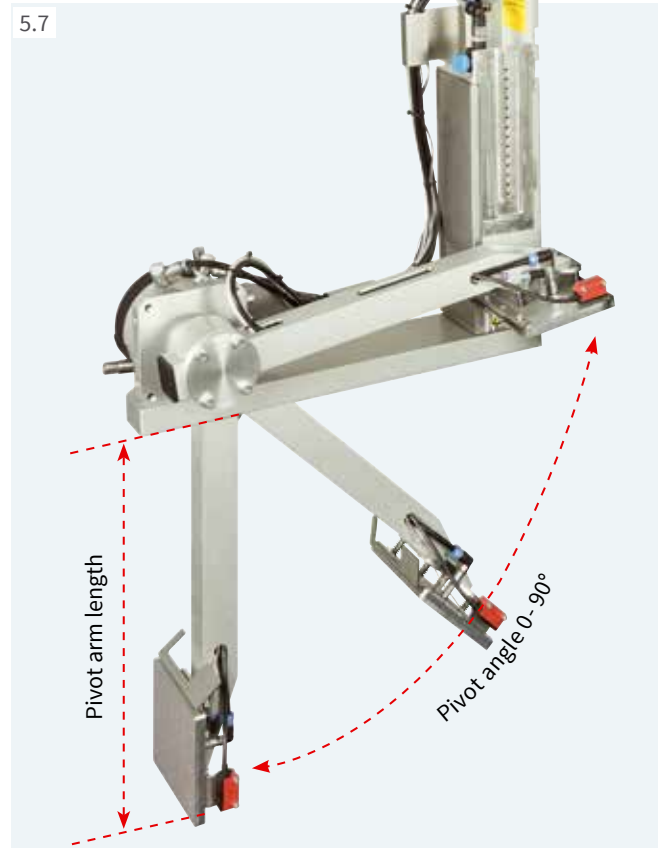

Tamp pad

Labels are precisely tamped on plain surfaces, even recessed.

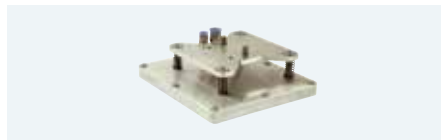

Tamp pad spring-mounted

The spring-mounted suction plate allows labeling on inclined surfaces up to 15°. Deviation in height in the area of the label may not exceed 10 mm.



Blow pad

With 5 to 10 mm distance to the product surface, air jet blows the labels onto the product.

Technical data		Tamp pad		Tamp pad spring-mounted		Blow pad	
		3014, 3016 L/R 1100		3014, 3016 L/R 3100		3014 L/R 2100	
Label width	Hermes+ 4	mm	25 - 114	80 - 114	25 - 114		
	Hermes+ 6	mm	25 - 174	80 - 174	-		
Label height	Hermes+ 4	mm	8 - 250	80 - 250	10 - 100		
	Hermes+ 6	mm	25 - 250	80 - 250	25 - 100		
Product during labeling	not in motion			■			
	in motion			■			
Product labeling	from top			■			
	from the side			■			
	from the front			■			
	from the back			■			
Product height	variable			■			
Pivot arm length ¹⁾	mm			200 / 300 / 400			
Pivot angle				0 - 90°			
Compressed air	bar			4.5			
Cycle time ²⁾	approx. labels/min			15			

¹⁾ Pivot arm length is defined as the accessible 90° label position (lower edge of the label) below the footprint of Hermes+.

²⁾ Calculated with pivot arm length 200 mm, label height 100 mm, print speed 100 mm/s

Package marking

Stroke applicators 4014, 4016

for real-time labeling on packaging or products. Depending on the type of pad, the product is either in motion or not in motion during labeling. Labeling is possible from all sides.

The pad is positioned in front of the peel-off plate. The label is held during printing. The stroke cylinder applies the label on the product. A sensor detects the product and moves back the pad to its initial position. The length of the stroke cylinder defines the maximum product distance to the peel-off plate.



Accessories

- 5.13 **Blow tube**
- 5.14 **Compressed air regulation unit**
- 5.15 **Compressed air regulation unit with ON/OFF valve**
- 5.17 **Pressure reducing valve**

5.8

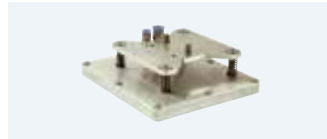

Tamp pad

Labels are precisely tamped on plain surfaces, even recessed.

Universal pad

Labels are tamped on plain surfaces. Holes to suck the labels are pre-drilled in gaps of 5 mm and are covered by a sliding foil. They are opened with a punching tool, according to the label size. Delivery includes two foils for substitution.

Tamp pad spring-mounted

The spring-mounted suction plate allows labeling on inclined surfaces up to 15°. Deviation in height in the area of the label may not exceed 10 mm.

Universal pad spring-mounted

The spring-mounted suction plate allows labeling on inclined surfaces up to 15°. Deviation in height in the area of the label may not exceed 10 mm. Holes to suck the labels are pre-drilled in gaps of 5 mm and are covered by a sliding foil. Delivery includes two foils for substitution.

			Tamp pad	Universal pad	Tamp pad spring-mounted	Universal pad spring-mounted
Technical data			4014, 4016 L/R 11 F	4014 L/R 1100	4014, 4016 L/R 3100	4014 L/R 3100
Label width	Hermes ⁺ 4	mm	20 - 114	75 / 90	80 - 114	116 / 116
	Hermes ⁺ 6	mm	50 - 174	-	80 - 174	-
Label height	Hermes ⁺ 4	mm	20 - 210	60 / 90	80 - 210	102 / 152
	Hermes ⁺ 6	mm	25 - 210	-	80 - 210	-
Product during labeling	not in motion				■	
Product labeling	from top				■	
	from below				■	
	from the side				■	
Product height	variable				■	
Product distance to lower edge of device at cylinder stroke 200	up to mm		135	135	130	130
	300	up to mm	235	235	230	230
	400	up to mm	335	335	330	330
Immersion depth pad F ¹⁾	up to mm		120	-	-	-
Compressed air	bar				4.5	
Cycle time ²⁾	approx. labels/min				25	

¹⁾ In case the applicator's immersion depth is more than 25 mm, the cover of Hermes⁺ has to be adapted.

²⁾ Calculated with stroke 100 mm below device, label height 100 mm, print speed 100 mm/s

Package marking

Stroke applicators 4014, 4016

for real-time labeling on packaging or products. Depending on the type of pad, the product is either in motion or not in motion during labeling. Labeling is possible from all sides.

The pad is positioned in front of the peel-off plate. The label is held during printing. The stroke cylinder applies the label on the product. A sensor detects the product and moves back the pad to its initial position. The length of the stroke cylinder defines the maximum product distance to the peel-off plate.



Accessories

- 5.13 **Blow tube**
- 5.14 **Compressed air regulation unit**
- 5.15 **Compressed air regulation unit with ON/OFF valve**
- 5.17 **Pressure reducing valve**



Blow pad

for pressure sensitive surfaces or when products are in motion. Air jet blows the labels onto the product.

5 to 10 mm distance to the product surface are set with a stop on the stroke cylinder.

Roll-on pad

Labels are rolled on plain surfaces of the product during transport.

Corner-wrap pad

Labels are attached on two adjacent sides of the product. Half of the label is applied by the pad on the top side. Then the second half of the label is rolled on.

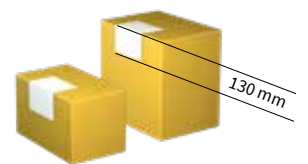

Technical data			Blow pad	Roll-on pad	Corner-wrap pad
			4014 L/R 2100	4014, 4016 L/R 4100	4014 L/R 5100
Label width	Hermes+ 4	mm	20 - 114	25 - 114	20 - 114
	Hermes+ 6	mm	on request	50 - 174	-
Label height	Hermes+ 4	mm	20 - 100	80 - 250	60 - 210
	Hermes+ 6	mm	on request	80 - 250	-
Product during labeling	not in motion		■	-	■
	in motion		■	■	-
Product labeling	from top		-	■	-
	from below		■	■	-
	from the side		■	■	-
Product height	fixed		■	-	-
	variable		-	■	■
Product distance to lower edge of device	at cylinder stroke 200	up to mm	140	160	100
	300	up to mm	240	260	200
	400	up to mm	340	360	300
Compressed air		bar		4.5	
Cycle time ¹⁾	approx. labels/min		25	20	20

¹⁾ Calculated with stroke 100 mm below device, label height 100 mm, print speed 100 mm/s

Package marking

Stroke blow applicator 4614

for real-time labeling of packaging of different heights in motion. Labeling is possible from all sides.

The pad is positioned in front of the peel-off plate. The label is held during printing. Sensor controlled, the stroke cylinder moves the pad to a position approximately 10 mm above the packaging. The length of the stroke cylinder defines the maximum differences in height of the packages.



Accessories

- 5.13 **Blow tube**
- 5.14 **Compressed air regulation unit**
- 5.15 **Compressed air regulation unit with ON/OFF valve**

5.9



Blow pad

With 5 to 10 mm distance to the product surface, air jet blows the labels onto the product.

Technical data			Blow pad 4614 L/R 2100
Label width	Hermes+ 4	mm	20 - 114
	Hermes+ 6	mm	on request
Label height	Hermes+ 4	mm	20 - 100
	Hermes+ 6	mm	on request
Product during labeling	not in motion		■
	in motion		■
Product labeling	from top		■
	from below		■
	from the side		■
Product height	fixed		■
	variable		■
Product distance to lower edge of device at cylinder stroke	200	up to mm	140
	300	up to mm	240
	400	up to mm	340
Compressed air		bar	4.5
Cycle time ¹⁾		approx. labels/min	25

¹⁾ Calculated with cylinder stroke 100 mm below device, label height 100 mm, print speed 100 mm/s

Package marking

Demand module 5114

for serial labeling of packaging in motion. The label position on the peel-off tongue is adjusted with the adjustable rewind assist roller. Labeling is possible from all sides.

During labeling, the next label is printed simultaneously. The conveyor belt speed has to be adapted to the print speed.

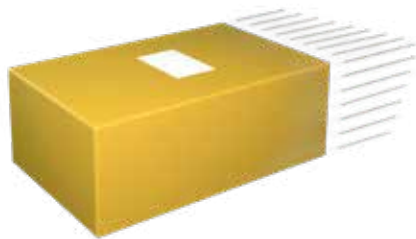

Technical data		Demand module	
		5114 L/R	
Label width Hermes+ 4	mm	25 - 114	
Label height	mm	25 - 250	
Print line distance to peel-off plate	mm	400 - 600	
Product during labeling	in motion	■	
Product labeling	from top	■	
	from below	■	
	from the side	■	
Product height	fixed	■	
Product distance to lower edge of device	mm	80	
Product speed	mm/s	must correspond to the print speed / 50 - 250 in steps of 25	
Cycle time ¹⁾	approx. labels/min	60	

¹⁾ Calculated with label height 100 mm, print speed 100 mm/s

Package marking

Vacuum belt applicators 5314, 5316, 5414, 5416

for real-time labeling on packaging or products in motion. Labeling is possible from all sides on plain surfaces, cylinders resp. corner-wrap.

The vacuum belt applicator is positioned in front of the peel-off plate. The printed label is transferred by the vacuum conveyor belt to the demand position and labeled on the packaging by an external signal.

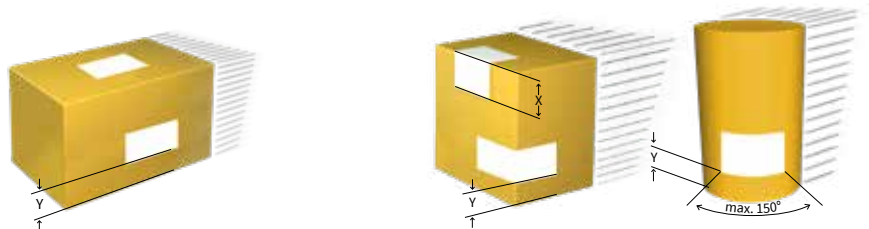
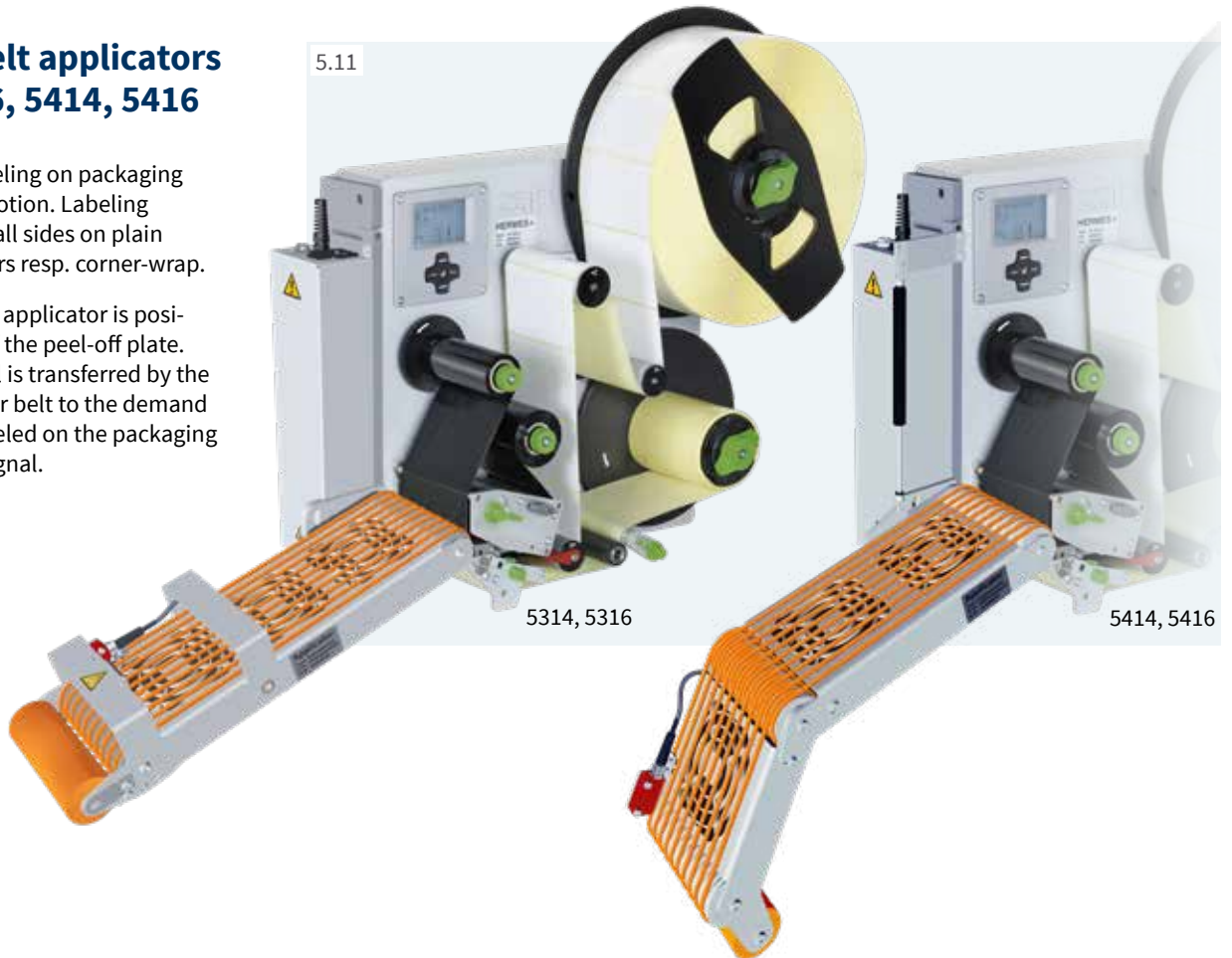

			Vacuum belt applicator			
Technical data			5314-3	5316-3	5414-3	5416-3
Labeling			on the surface		on the surface, a cylinder or corner-wrap	
Direction of label demand			left and right			
Label width	Hermes+ 4	mm	20 - 114	-	20 - 114	-
	Hermes+ 6	mm	-	46 - 174	-	46 - 174
Label height		mm	60 - 356	60 - 356	80 - 356	80 - 356
Product during labeling		in motion			■	
Product labeling		from top			■	
		from below	■	■	-	-
		from the side			■	
Product height		fixed	■			■
		variable	-			■
Product speed		up to m/s	0.5	0.5	0.3	0.3
Gap between products		min. m	0.5			
Stability on application level			-	-	F ¹⁾ = 30 N	F ¹⁾ = 30 N
Corner-wrap labeling		up to mm	-	-	dimension X = 160	dimension X = 160
Vacuum conveyor belt speed ²⁾		mm/s	100 - 500	100 - 500	100 - 300	100 - 300
Cycle time ³⁾		up to labels/min	30	30	15	15
Label distance to conveyor belt when labeling from the side		mm	dimension Y = 20			

¹⁾ F = force required to swing the vacuum conveyor belt

²⁾ The product speed must be equal or higher than the vacuum conveyor belt speed.

³⁾ Calculated with label height 100 mm, print speed 250 mm/s

Package marking

Air jet box 6114

for fast labeling in motion or not in motion. The labels are sucked by a fan and blown off by a powerful blast of air through aligned nozzles. The maximum distance from the packaging to the peel-off plate is 200 mm, depending on the label size.

Accessories

5.13 Blow tube

5.16 **Compressed air regulation unit with shut-off valve** for fully venting the hose lines after the compressed air regulation unit; provided as left hand or right hand version



1 Template

to cover the suction and air jet holes around the label

It is pre-scored in a hole pattern of 8 x 8 mm and can be easily adapted to the label size. By sliding in between the suction block and the slide bars, the area around the label is covered. Five templates are included in the scope of delivery.

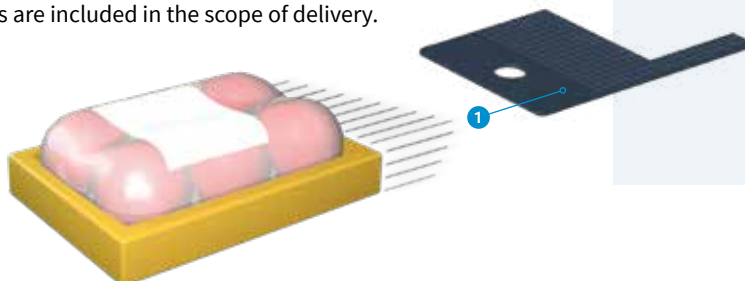

5.12

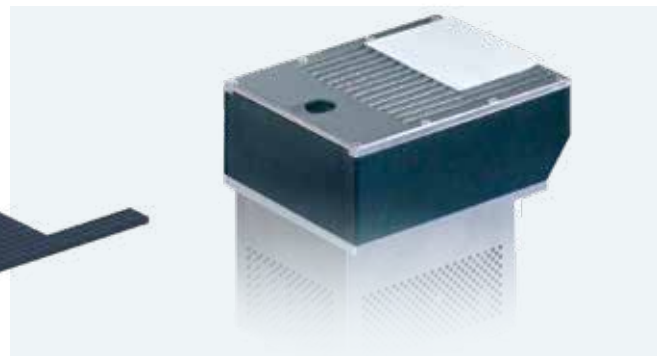

Technical data		Air jet box 6114 L/R	
Label width Hermes+ 4	mm	50-114	smaller sizes on request
Label height	mm	50-125	smaller sizes on request
Product during labeling	not in motion	■	
	in motion	■	
Product labeling	from top	■	
	from below	■	
	from the side	■	
Product height	variable	■	
Product distance to peel-off plate	up to mm	200	
Compressed air	bar	4.5 - 6	
Cycle time ¹⁾	up to labels/min	100	

¹⁾ Calculated with label height 50 mm, print speed 250 mm/s, blowing time 100 ms and a distance of 100 mm from the product to the peel-off plate

Overview of accessories

■ Standard □ Option

		1.1	1.2	1.3
Hermes+ accessories		Hermes+ 2	Hermes+ 4	Hermes+ 6
Pos.	Extra equipment			
2.1	Cover	□	□	□
2.2	External operation panel	□	□	□
2.3	Standard keyboard DE	□	□	□
2.4	CompactFlash Type I memory card	□	□	□
2.5	Product sensor 25 pin to connect to Hermes+	□	□	□
2.6	Product sensor 3 pin to connect to a front side applicator, vacuum belt applicator, air jet box	-	□	-
2.7	I/O interface connector	□	□	□
2.8	Warning light	□	□	□
2.9	Circular connector	□	□	□
2.10	Extended peel-off plate +10 mm	□	□	□
2.11	Margin stop	□	□	□
2.12	Antistatic brush	□	□	-
	Interfaces, switches			
3.1	Centronics	□	□	□
3.2	RS422/RS485	□	□	□
3.3	Label selection - I/O box	□	□	□
3.4	I/O interface adapter	□	□	□
3.5	Hand switch TR2	□	□	□
3.6	Foot switch	□	□	□
	Connecting cables			
4.1	Connecting cable RS232-C, 9/9 pin, length 3 m	□	□	□
4.2	Patch cable CAT5e, length 3 m, grey	□	□	□
	Mounting equipment			
6.1	Adapter plate	□	□	□
6.2	Profiles 40, 80, 120 mm	□	□	□
6.3	Base plate 500 x 255 mm	□	□	-
6.4	Mounting plate	□	□	□
6.5	Bracket	□	□	□
6.6	Clamped joint for profile 50 x 50 mm	□	□	□
6.7	Flanged joint for profile 50 x 50 mm	□	□	□
6.8	Floor stand 1601	□	□	□
6.9	Floor stand 1602	□	□	□

		5.1	5.2	5.3	5.4	5.5	5.6	5.7	5.8	5.9	5.12
Applicator accessories		3214	4114 4116	4214	4414	4514	4712	3014 3016	4014 4016	4614	6114
Pos.	Extra equipment										
5.13	Blow tube	■	■	■	■	■	■	■	■	■	■
5.14	Compressed air regulation unit	□	□	□	□	□	□	□	□	□	□
5.15	Compressed air regulation unit with ON/OFF valve	□	□	□	□	□	□	□	□	□	-
5.16	Compressed air regulation unit with shut-off valve	-	-	-	-	-	-	-	-	-	■
5.17	Pressure reducing valve	-	□	□	□	-	-	-	□	-	-

Hermes+ accessories

Extra equipment	
2.1 	Cover for label roll diameters up to 205 mm. To protect from dirt and contact. In case the applicators's immersion depth is more than 25 mm, the cover has to be adapted. Approved for vertical assembly
2.2 	External operation panel If the operation panel is not accessible after printer installation, an external one can be additionally connected. A port to insert a CompactFlash Type I memory card as well as a USB host interface are also in place.
2.3 	Standard keyboard DE USB connected, 115 keys
2.4 	CompactFlash Type I memory card to store label formats, fonts, text and graphics. Readable and writable in the printer or on a PC
2.5 	Product sensor 25 pin to connect to Hermes+. In case a product has been detached, e.g. on a conveyor belt, labeling is started.
2.6 	Product sensor 3 pin to connect to a front side applicator, vacuum belt applicator or air jet box. In case a product has been detached, e.g. on a conveyor belt, labeling is started.
2.7 	I/O interface connector with clamping screws to connect all control signals to the I/O interface of Hermes+
2.8 	Warning light In addition to the display, it indicates the printer status. Delivery includes a connecting cable and material to assemble to the chassis or the bracket.
Extra equipment	
2.9 	Circular connector in case wiring is provided by the customer; 3 pin M8 for the ON/OFF valve of the compressed air regulation unit 4 pin M8 for an external e-stop
2.10 	Extended peel-off plate +10 mm in case labels are hard to remove; on request
2.11 	Margin stop to guide small label materials
2.12 	Antistatic brush Particularly with plastic materials the electrostatic charge is discharged after printing.
Interfaces, switches	
3.1 	Centronics bidirectional according to IEEE 1284
3.2 	RS422/RS485 1,200 to 230,400 baud/8 bit
3.3 	Label selection - I/O box Up to 16 different labels per box can be selected from the memory card.
3.4 	I/O interface adapter to adapt the 15 pin plug of Hermes A to the 25 pin plug of Hermes+.
3.5 	Hand switch TR2 to connect to the digital I/O interface
3.6 	Foot switch to connect to the digital I/O interface
Connecting cables	
4.1 	Connecting cable RS232-C 9/9 pin, length 3 m
4.2 	Patch cable CAT5e length 3 m, grey

Hermes+ mounting equipment



Mounting foot

to install Hermes+ on a desk or in a production line;
provided as left hand and right hand versions

The size of the mounting foot can be adapted to the application.

1 Adapter plate

The labeling system is assembled to the adapter plate.
It may also be assembled with the adapter plate to the profile
directly in the production line.

2 Profile

Aluminum square profile, standard lengths are 40, 80, 120 mm;
customized lengths are possible

3 Base plate

to assemble the product holder; standard size is 500 x 255 mm

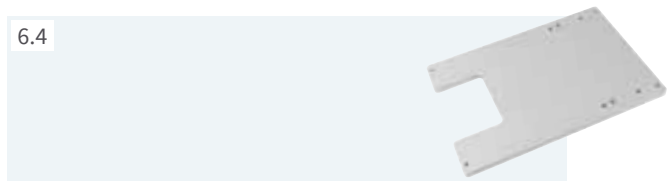

Mounting plate

to assemble Hermes+ directly in the production line



Bracket

to assemble Hermes+ to the floor stand

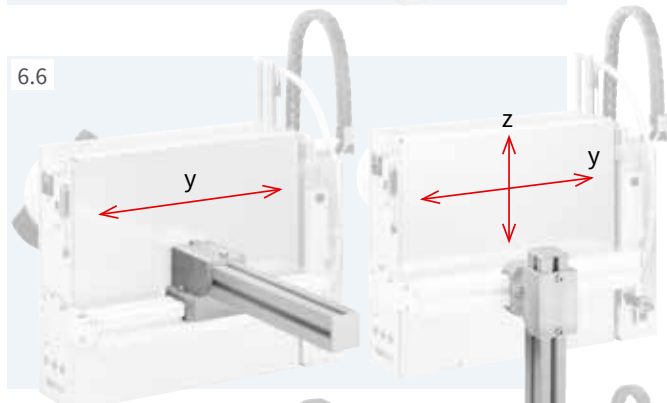

Clamped joint for profile 50 x 50 mm

to move the labeling system horizontally and vertically

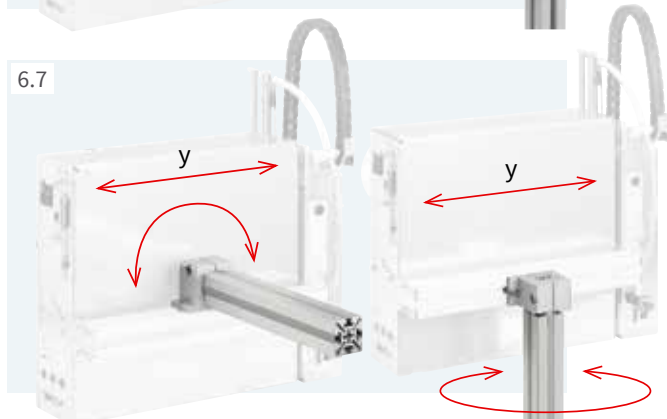

Flanged joint for profile 50 x 50 mm

to move the labeling system horizontally
and rotate it around an axis

Hermes+ floor stands

They help to install Hermes+ in a production line. Thanks to the adjustment options, Hermes+ can be positioned in three axes to the product to be labeled. Pivoting is also possible.

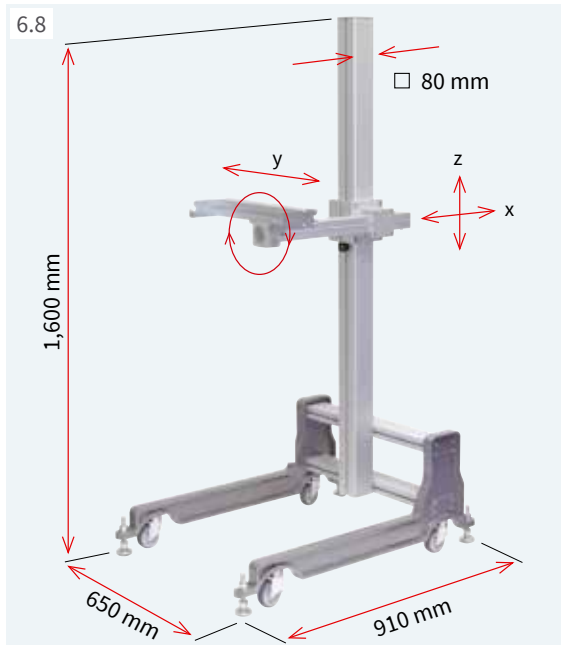

Floor stand 1601

Preferred use is with applications in different production lines. The mobile floor stand can be aligned with adjustable feet at the place of application.

		Floor stand
		1601
Technical data		
Base frame		Castors, adjustable feet
Height and depth adjustment		Screw clamping
Load in case of offset 500 mm	up to kg	50
Weight	kg	36

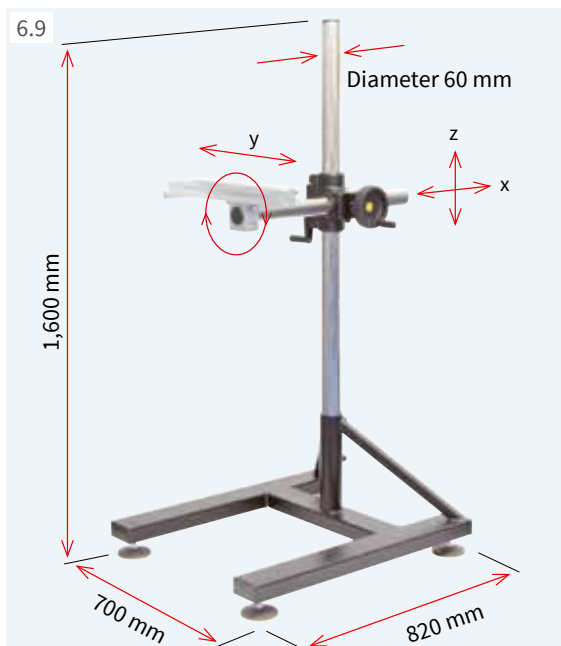

Floor stand 1602

Preferred use is with applications in which the heights and depths of the labeling position have to be changed frequently. By means of the toothed rack construction, Hermes+ can be arranged in x and z direction to the product.

		Floor stand
		1602
Technical data		
Base frame		Adjustable feet
Height adjustment		Toothed rack / crank
Depth adjustment		Toothed rack / handwheel
Load in case of offset 500 mm	up to kg	50
Weight	kg	38

Examples of stand assembly

Labeling in direction of transport from top

from the side



Labeling crosswise to the direction of transport from top

from the side

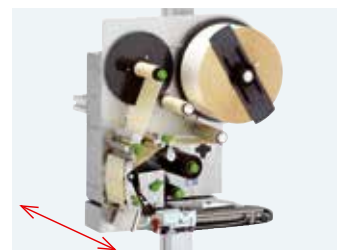
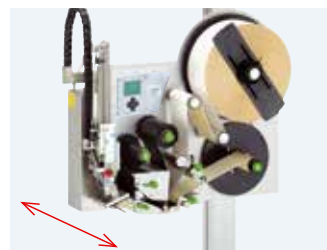

Applicator accessories

5.13



Blow tube

supporting with air. To assist the label transfer, the label is blown from below to the pad.

Provided for 2", 4" or 6" label applications

5.14



Compressed air regulation unit

for compressed air preparation; default setting 4.5 bar

Provided as left hand or right hand version

Delivery includes a fine filter, pressure control valve, pressure display, a hose to be connected to the applicator's compressed air input and material to assemble to the chassis or bracket.

5.15



Compressed air regulation unit with ON/OFF valve

In case the labeling system is part of a plant, compressed air supplying the applicator can be switched on or off.

Only if combined with an e-stop. Default setting 4.5 bar

Provided as left hand or right hand version

Delivery as 5.14, added by an ON/OFF valve and a mating plug to be connected to an external e-stop

5.17



Pressure reducing valve

to reduce the pressure of the stroke cylinder contacting the product

For applicators 4014/4016, 4114/4116, 4214, 4414

Examples of compressed air regulation unit assembly

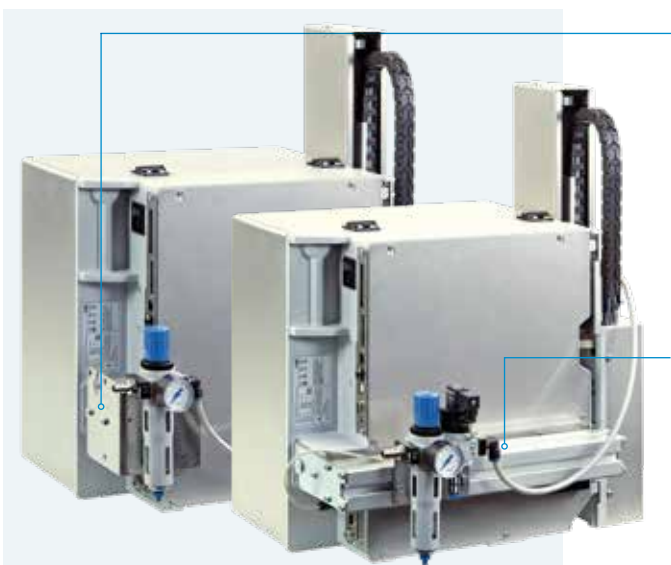

Regulation unit assembly
with material to attach to the chassis

Regulation unit with ON/OFF valve assembly
with material to attach to the bracket

Delivery program label printers

Pos.	Part no.	Printers L	Part no.	Print heads	dpi	Part no.	Print rollers	Part no.	Draw rollers
1.1	5955502	Label printer Hermes+ 2L/300-2	5954105.001	Print head 2	300	5954102.001	Print roller DR2	5961015.001	Draw roller ZR2
	5955503	Label printer Hermes+ 2L/600-2	5958686.001	Print head 2	600				
1.2	5955504	Label printer Hermes+ 4L/200-2	5954081.001	Print head 4	203	5954180.001	Print roller DR4	5961298.001	Draw roller ZR4
	5955505	Label printer Hermes+ 4L/300-2	5954072.001	Print head 4	300				
	5955506	Label printer Hermes+ 4L/600-2	5954077.001	Print head 4	600				
	5955507	Label printer Hermes+ 4.3L/200-2	5954085.001	Print head 4.3	203				
	5955508	Label printer Hermes+ 4.3L/300-2	5954089.001	Print head 4.3	300				
1.3	5955509	Label printer Hermes+ 6L/200-2	5954217.001	Print head 6	203	5954245.001	Print roller DR6	5961220.001	Draw roller ZR6
	5955510	Label printer Hermes+ 6L/300-2	5956322.001	Print head 6	300				
1.1	5961410	Label printer Hermes+ 2L/300-3	5954105.001	Print head 2	300	5954102.001	Print roller DR2	5961015.001	Draw roller ZR2
	5961411	Label printer Hermes+ 2L/600-3	5958686.001	Print head 2	600				
1.2	5955511	Label printer Hermes+ 4L/200-3	5954081.001	Print head 4	203	5954180.001	Print roller DR4	5961298.001	Draw roller ZR4
	5955512	Label printer Hermes+ 4L/300-3	5954072.001	Print head 4	300				
	5955513	Label printer Hermes+ 4L/600-3	5954077.001	Print head 4	600				
	5955514	Label printer Hermes+ 4.3L/200-3	5954085.001	Print head 4	203				
	5955515	Label printer Hermes+ 4.3L/300-3	5954089.001	Print head 4.3	300				
1.3	5955516	Label printer Hermes+ 6L/200-3	5954217.001	Print head 6	203	5954245.001	Print roller DR6	5961220.001	Draw roller ZR6
	5955517	Label printer Hermes+ 6L/300-3	5956322.001	Print head 6	300				
Pos.	Part no.	Printers R	Part no.	Print heads	dpi	Part no.	Print rollers	Part no.	Draw rollers
1.1	5955752	Label printer Hermes+ 2R/300-2	5954105.001	Print head 2	300	5954102.001	Print roller DR2	5961015.001	Draw roller ZR2
	5955753	Label printer Hermes+ 2R/600-2	5958686.001	Print head 2	600				
1.2	5955754	Label printer Hermes+ 4R/200-2	5954081.001	Print head 4	203	5954180.001	Print roller DR4	5961298.001	Draw roller ZR4
	5955755	Label printer Hermes+ 4R/300-2	5954072.001	Print head 4	300				
	5955756	Label printer Hermes+ 4R/600-2	5954077.001	Druckkopf 4	600				
	5955757	Label printer Hermes+ 4.3R/200-2	5954085.001	Print head 4.3	203				
	5955758	Label printer Hermes+ 4.3R/300-2	5954089.001	Print head 4.3	300				
1.3	5955759	Label printer Hermes+ 6R/200-2	5954217.001	Print head 6	203	5954245.001	Print roller DR6	5961220.001	Draw roller ZR6
	5955760	Label printer Hermes+ 6R/300-2	5956322.001	Print head 6	300				
1.1	5961412	Label printer Hermes+ 2R/300-3	5954105.001	Print head 2	300	5954102.001	Print roller DR2	5961015.001	Draw roller ZR2
	5961413	Label printer Hermes+ 2R/600-3	5958686.001	Print head 2	600				
1.2	5955761	Label printer Hermes+ 4R/200-3	5954081.001	Print head 4	203	5954180.001	Print roller DR4	5961298.001	Draw roller ZR4
	5955762	Label printer Hermes+ 4R/300-3	5954072.001	Print head 4	300				
	5955763	Label printer Hermes+ 4R/600-3	5954077.001	Print head 4	600				
	5955764	Label printer Hermes+ 4.3R/200-3	5954085.001	Print head 4.3	203				
	5955765	Label printer Hermes+ 4.3R/300-3	5954089.001	Print head 4.3	300				
1.3	5955766	Label printer Hermes+ 6R/200-3	5954217.001	Print head 6	203	5954245.001	Print roller DR6	5961220.001	Draw roller ZR6
	5955767	Label printer Hermes+ 6R/300-3	5956322.001	Print head 6	300				

Part no.	Printer options
595xxxx.201	Printer with cover ¹⁾ "x" - choose device from Pos. 1.1-1.3
595xxxx.202	Printer with automatic ribbon saving ²⁾ "x" - choose device from Pos. 1.1-1.3
595xxxx.203	Printer with cover ¹⁾ and automatic ribbon saving ²⁾ "x" - choose device from Pos. 1.1-1.3
auf Anfrage	Printer supporting rolls with core diameter 40 mm ³⁾
5961406	Adapter for core diameter 50 mm

¹⁾ only with label roll outside diameters up to 205 mm

²⁾ only for Hermes+ 4 and Hermes+ 6

³⁾ only for Hermes+ 2 and Hermes+ 4

In case the applicator's immersion depth is more than 25 mm, the cover has to be adapted.

Type code		
Label printer Hermes+		4L/200-2
Label width	58 mm 2 114 mm 4 174 mm 6	
Direction of label demand	left L right R	
Printable resolution	203 dpi 200 300 dpi 300 600 dpi 600	
for label roll outside diameter	up to 205 mm 2	
for label roll outside diameter	up to 305 mm 3	













Scope of delivery												
Label printer Power cable Type E+F, length 1.8 m Connecting cable USB, length 1.8 m Assembly instructions DE/EN												
DVD: Assembly instructions in more than 20 languages Configuration manual DE/EN/FR Service manual DE/EN Spare parts list DE/EN Programming manual EN WHQL certified Windows printer drivers for <table border="0" style="margin-left: 20px;"> <tr> <td>Windows Vista</td> <td>Server 2008</td> </tr> <tr> <td>Windows 7</td> <td>Server 2008 R2</td> </tr> <tr> <td>Windows 8</td> <td>Server 2012</td> </tr> <tr> <td>Windows 8.1</td> <td>Server 2012 R2</td> </tr> <tr> <td>Windows 10</td> <td>Server 2016</td> </tr> <tr> <td></td> <td>Server 2019</td> </tr> </table> Apple Mac OS X printer drivers DE/EN/FR Linux printer drivers DE/EN/FR Label software cablabel S3 Lite cablabel S3 Viewer Database Connector	Windows Vista	Server 2008	Windows 7	Server 2008 R2	Windows 8	Server 2012	Windows 8.1	Server 2012 R2	Windows 10	Server 2016		Server 2019
Windows Vista	Server 2008											
Windows 7	Server 2008 R2											
Windows 8	Server 2012											
Windows 8.1	Server 2012 R2											
Windows 10	Server 2016											
	Server 2019											

Scopes of delivery, design and technical specifications correspond to the date of the printing. Subject to change. The data provided in the catalog do not represent any warranty or guarantee.













Information is also available on the Internet:
www.cab.de/en/hermesplus







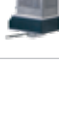













Delivery program applicators L and transfer modules













Pos.	Part no.	Applicators L	Part no.	Transfer modules	
5.1	 5970075	Swing applicator 3214L-40	xxxxxxx xxxxxxx xxxxxxx xxxxxxx	Tamp pad Tamp pad with damping layer Tamp pad with label stop Blow pad 3214L-11 F W x H 3214L-12 F W x H 3214L-61 F W x H 3214L-2100 W x H	
5.2	 5966109 5966110 5966111	Stroke applicator 4114L-200	xxxxxxx	Tamp pad 4114L-11 F W x H	
		Stroke applicator 4114L-300	xxxxxxx	Tamp pad with damping layer 4114L-12 F W x H	
		Stroke applicator 4114L-400	xxxxxxx	Tamp pad with label stop 4114L-61 F W x H	
			xxxxxxx	Blow pad 4114L-2100 W x H	
			xxxxxxx	Form pad 4114L-8800 W x H	
		5971795	Stroke applicator 4116L-200	xxxxxxx	Tamp pad 4116L-11 F W x H
		5972016	Stroke applicator 4116L-300	xxxxxxx	Tamp pad with damping layer 4116L-12 F W x H
		5972017	Stroke applicator 4116L-400	xxxxxxx	Tamp pad with label stop 4116L-61 F W x H
			xxxxxxx	Form pad 4116L-8800 W x H	
5.3	 5966117 5966118 5966119	Stroke turn applicator 4214L-200 Stroke turn applicator 4214L-300 Stroke turn applicator 4214L-400	xxxxxxx xxxxxxx xxxxxxx xxxxxxx	Tamp pad Tamp pad with damping layer Tamp pad with label stop Blow pad 4214L-11 F W x H 4214L-12 F W x H 4214L-61 F W x H 4214L-2100 W x H	
5.4	 5966133 5966134 5966135	Stroke applicator 4414L-200 Stroke applicator 4414L-300 Stroke applicator 4414L-400	xxxxxxx xxxxxxx xxxxxxx	Tamp pad Tamp pad with damping layer Tamp pad with label stop 4414L-11 F W x H 4414L-12 F W x H 4414L-61 F W x H	
5.5	 5971625 5966168 5971640	Swing stroke applicator 4514L-200 Swing stroke applicator 4514L-300 Swing stroke applicator 4514L-400	xxxxxxx	Blow pad 4514L-2100 W x H	
5.6	 5971815	Flag applicator 4712L-300			
5.7	 5970100 5970101 5970102	Front side applicator 3014L-200 Front side applicator 3014L-300 Front side applicator 3014L-400	xxxxxxx xxxxxxx xxxxxxx	Tamp pad Tamp pad spring-mounted Blow pad 3014L-1100 W x H 3014L-3100 W x H 3014L-2100 W x H	
		5970103	Front side applicator 3016L-200	xxxxxxx	Tamp pad 3016L-1100 W x H
		5970104	Front side applicator 3016L-300	xxxxxxx	Tamp pad spring-mounted 3016L-3100 W x H
		5970105	Front side applicator 3016L-400	xxxxxxx	
5.8	 5966101 5966102 5966103	Stroke applicator 4014L-200	5966147	Universal pad 4014L-1100 75 x 60	
		Stroke applicator 4014L-300	5966148	Universal pad 4014L-1100 90 x 90	
		Stroke applicator 4014L-400	5966149	Universal pad spring-mounted 4014L-3100 116 x 102	
			5966150	Universal pad spring-mounted 4014L-3100 116 x 152	
			xxxxxxx	Tamp pad 4014L-11 F W x H	
			xxxxxxx	Blow pad 4014L-2100 W x H	
			xxxxxxx	Tamp pad spring-mounted 4014L-3100 W x H	
			xxxxxxx	Roll-on pad 4014L-4100 W x H	
			xxxxxxx	Corner-wrap pad 4014L-5100 W x H / H	
		5966161	Stroke applicator 4016L-200	xxxxxxx	Tamp pad 4016L-11 F W x H
		5966162	Stroke applicator 4016L-300	xxxxxxx	Tamp pad spring-mounted 4016L-3100 W x H
		5966163	Stroke applicator 4016L-400	xxxxxxx	Roll-on pad 4016L-4100 W x H
5.9	 5971720 5971725 5971730	Stroke blow applicator 4614L-200 Stroke blow applicator 4614L-300 Stroke blow applicator 4614L-400	xxxxxxx	Blow pad 4614L-2100 W x H	
5.10	 5966144	Demand module 5114L			
5.11	 5972730 5972750	Vacuum belt applicator 5314L-3			
		Vacuum belt applicator 5316L-3			
		5972940	Vacuum belt applicator 5414L-3		
		5972920	Vacuum belt applicator 5416L-3		
5.12	 5984810	Air jet box 5 templates included 6114L	5984709.001	Template (5 included in pack unit) 6114 L/R	

Delivery program applicators R and transfer modules







Pos.	Part no.	Applicators R	Part no.	Transfer modules
5.1	 5971655	Swing applicator 3214R-40	xxxxxxx xxxxxxx xxxxxxx xxxxxxx	Tamp pad Tamp pad with damping layer Tamp pad with label stop Blow pad 3214R-11 F W x H 3214R-12 F W x H 3214R-61 F W x H 3214R-2100 W x H
5.2	 5966113 5966114 5966115	Stroke applicator 4114R-200 Stroke applicator 4114R-300 Stroke applicator 4114R-400	xxxxxxx xxxxxxx xxxxxxx xxxxxxx xxxxxxx	Tamp pad Tamp pad with damping layer Tamp pad with label stop Blow pad Form pad 4114R-11 F W x H 4114R-12 F W x H 4114R-61 F W x H 4114R-2100 W x H 4114R-8800 W x H
	5972018 5972019 5972020	Stroke applicator 4116R-200 Stroke applicator 4116R-300 Stroke applicator 4116R-400	xxxxxxx xxxxxxx xxxxxxx xxxxxxx	Tamp pad Tamp pad with damping layer Tamp pad with label stop Form pad 4116R-11 F W x H 4116R-12 F W x H 4116R-61 F W x H 4116R-8800 W x H
5.3	 5966121 5966122 5966123	Stroke turn applicator 4214R-200 Stroke turn applicator 4214R-300 Stroke turn applicator 4214R-400	xxxxxxx xxxxxxx xxxxxxx xxxxxxx	Tamp pad Tamp pad with damping layer Tamp pad with label stop Blow pad 4214R-11 F W x H 4214R-12 F W x H 4214R-61 F W x H 4214R-2100 W x H
5.4	 5966137 5966138 5966139	Stroke applicator 4414R-200 Stroke applicator 4414R-300 Stroke applicator 4414R-400	xxxxxxx xxxxxxx xxxxxxx	Tamp pad Tamp pad with damping layer Tamp pad with label stop 4414R-11 F W x H 4414R-12 F W x H 4414R-61 F W x H
5.5	 5966950 5971460 5971700	Swing stroke applicator 4514R-200 Swing stroke applicator 4514R-300 Swing stroke applicator 4514R-400	xxxxxxx	Blow pad 4514R-2100 W x H
5.7	 5970106 5970107 5970108	Front side applicator 3014R-200 Front side applicator 3014R-300 Front side applicator 3014R-400	xxxxxxx xxxxxxx xxxxxxx	Tamp pad Tamp pad spring-mounted Blow pad 3014R-1100 W x H 3014R-3100 W x H 3014R-2100 W x H
	5970109 5970110 5970111	Front side applicator 3016R-200 Front side applicator 3016R-300 Front side applicator 3016R-400	xxxxxxx xxxxxxx	Tamp pad Tamp pad spring-mounted 3016R-1100 W x H 3016R-3100 W x H
5.8	 5966105 5966106 5966107	Stroke applicator 4014R-200 Stroke applicator 4014R-300 Stroke applicator 4014R-400	5966140 5966141 5966142 5966143	Universal pad Universal pad Universal pad spring-mounted Universal pad spring-mounted 4014R-1100 75 x 60 4014R-1100 90 x 90 4014R-3100 116 x 102 4014R-3100 116 x 152
	5966165 5966166 5966167	Stroke applicator 4016R-200 Stroke applicator 4016R-300 Stroke applicator 4016R-400	xxxxxxx xxxxxxx xxxxxxx	Tamp pad Tamp pad spring-mounted Roll-on pad 4016R-11 F W x H 4016R-3100 W x H 4016R-4100 W x H
5.9	 5971735 5971740 5971745	Stroke blow applicator 4614R-200 Stroke blow applicator 4614R-300 Stroke blow applicator 4614R-400	xxxxxxx	Blow pad 4614R-2100 W x H
5.10	 5966145	Demand module 5114R		
5.11	 5972740 5972760	Vacuum belt applicator 5314R-3 Vacuum belt applicator 5316R-3		
	5972950 5972930	Vacuum belt applicator 5414R-3 Vacuum belt applicator 5416R-3		
5.12	 5984800	Air jet box 5 templates included 6114R	5984709.001	Template (5 included in pack unit) 6114 L/R



Delivery program Hermes+

Pos.	Part no.	Extra equipment
2.1	 5961000.001	Cover 2L
	 5961070.001	Cover 4L
	 5961193.001	Cover 6L
2.2	 5961190.001	Cover 2R
	 5961187.001	Cover 4R
	 5961196.001	Cover 6R
2.2	 5954380	External operation panel
2.3	 5901626	Standard keyboard DE
2.4	 5561043	CompactFlash Type I memory card
2.5	 5964300	Product sensor 25 pin
2.6	 5970071	Product sensor 3 pin
2.7	 5917651	I/O interface connector SUB-D, 25 pin
2.8	 5961237.001	Warning light
2.9	 5918092	Circular connector 3 pin M8
	 5918003	Circular connector 4 pin M8
2.10	 5961625	Extended peel-off plate Hermes+ 2
	 5961624	Extended peel-off plate Hermes+ 4
	 5961658	Extended peel-off plate Hermes+ 6
2.11	 5961650	Margin stop
2.12	 5961640	Antistatic brush Hermes+ 2L
	 5961642	Antistatic brush Hermes+ 2R
	 5961644	Antistatic brush Hermes+ 4L
	5961646	Antistatic brush Hermes+ 4R
Pos.	Part no.	Interfaces, switches
3.1	5954200	Centronics
3.2	5954201	RS422 / RS485
3.3	5948205	Label selection - I/O box
3.4	5961349	I/O interface adapter
3.5	5955710	Hand switch TR2
3.6	5955711	Foot switch

Pos.	Part no.	Connecting cables
4.1	 5550818	Connecting cable RS232-C 9/9 pin, length 3 m
4.2	 5918008	Patch cable CAT 5e length 3 m, grey
Pos.	Part no.	Mounting equipment
6.1	 5965940	Adapter plate
6.2	 on request	Profile (customized length)
6.3	 5961203	Base plate 500 x 255 mm
6.4	 5958400	Mounting plate
6.5	 5955685	Bracket
6.6	 8914443	Clamped joint for profile 50 x 50 mm
6.7	 8914444	Flanged joint for profile 50 x 50 mm
6.8	 5970113	Floor stand 1601
6.9	 5970112	Floor stand 1602
Pos.	Part no.	Label software
7.6		Bundle cablabel S3 Lite (Download at cab.de/en)
	5588001	cablabel S3 Pro 1 WS
	5588100	cablabel S3 Pro 5 WS
	5588101	cablabel S3 Pro 10 WS
	5588150	cablabel S3 Pro 1 additional licence
	5588151	cablabel S3 Pro 4 additional licences
	5588152	cablabel S3 Pro 9 additional licences
	5588002	cablabel S3 Print 1 WS
	5588105	cablabel S3 Print 5 WS
	5588106	cablabel S3 Print 10 WS
5588155	cablabel S3 Print 1 additional licence	
5588156	cablabel S3 Print 4 additional licences	
5588157	cablabel S3 Print 9 additional licences	
		in preparation cablabel S3 Print Server
7.10	 9008486	Programming manual EN, printed copy

Delivery program applicators

Pos.	Part no.	Extra equipment
5.13	 5964277.001	Blow tube 2"
	 5964095.001	Blow tube 4"
	 5964614.001	Blow tube 6"
5.14	 5955735	Compressed air regulation unit L
	 5955736	Compressed air regulation unit R
5.15	 5955737	Compressed air regulation unit L with ON/OFF valve
	 5955738	Compressed air regulation unit R with ON/OFF valve

Pos.	Part no.	Extra equipment
5.16	 5984805	Compressed air regulation unit L with shut-off valve for air jet box 6114L
	 5984795	Compressed air regulation unit R with shut-off valve for air jet box 6114R
5.17	 596xxxx.212	Pressure reducing valve

cab product overview

Label printers
MACH1, MACH2



Label printers
EOS 2



Label printers
EOS 5



Label printers
MACH 4S



Label printers
SQUIX 2



Label printers
SQUIX 4



Label printers
SQUIX 6.3



Label printer
A8+



Label printer
XD4T



Label printers
XC



Print and apply systems
HERMES Q



Print and apply systems
Hermes C

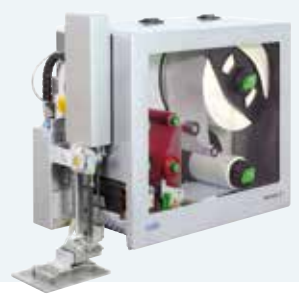

Tube labeling systems
AXON



Print modules
PX Q



Labels and ribbons



Label software
cablabel S3



Label dispensers
HS, VS



Labeling heads
IXOR



Marking lasers
XENO 4



Laser marking systems



Germany
cab Produkttechnik GmbH & Co KG
Karlsruhe
Phone +49 721 6626 0
www.cab.de

France
cab Technologies S.à.r.l.
Niedermodern
Phone +33 388 722501
www.cab.de/fr

USA
cab Technology, Inc.
Chelmsford, MA
Phone +1 978 250 8321
www.cab.de/us

Mexico
cab Technology, Inc.
Juárez
Phone +52 656 682 4301
www.cab.de/es

Taiwan
cab Technology Co., Ltd.
Taipei
Phone +886 (02) 8227 3966
www.cab.de/tw

China
cab (Shanghai) Trading Co., Ltd.
Shanghai
Phone +86 (021) 6236 3161
www.cab.de/cn

China
cab (Shanghai) Trading Co., Ltd.
Guangzhou
Phone +86 (020) 2831 7358
www.cab.de/cn

South Africa
cab Technology (Pty) Ltd.
Randburg
Phone +27 11 886 3580
www.cab.de/za

cab // 820 distribution partners in more than 80 countries

cab
we identify more